

# P-51H

## MUSTANG

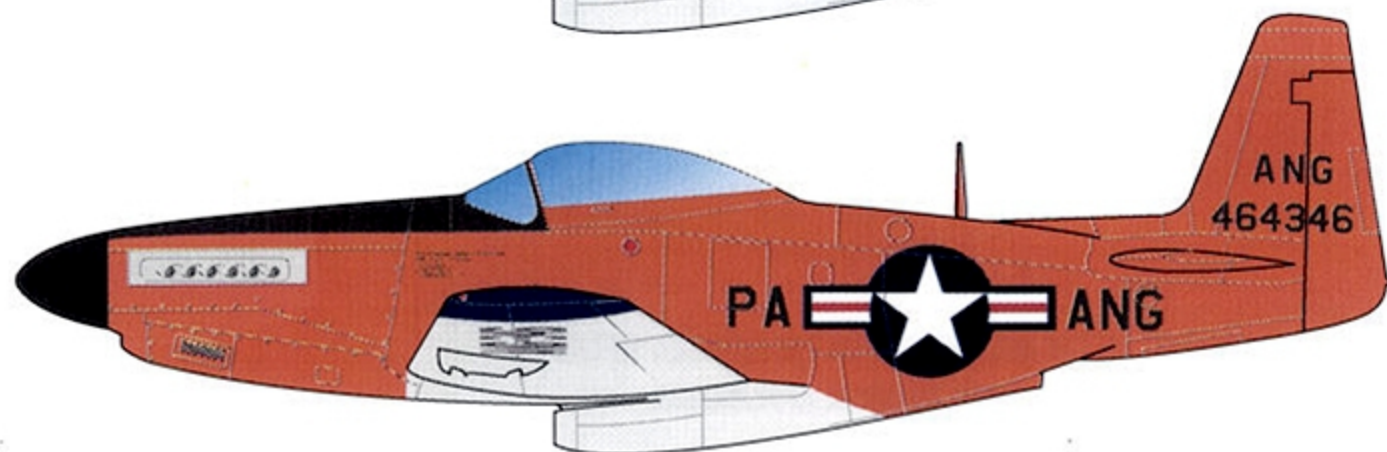

**NINE MARKING OPTIONS  
FOR P-51H POSTWAR MUSTANGS  
DESIGNED FOR THE MODELSVIT KIT**

# 1/48 SCALE

**DECALS PRINTED BY**



**OPTION 1: F-51H MUSTANG, 44-64203**

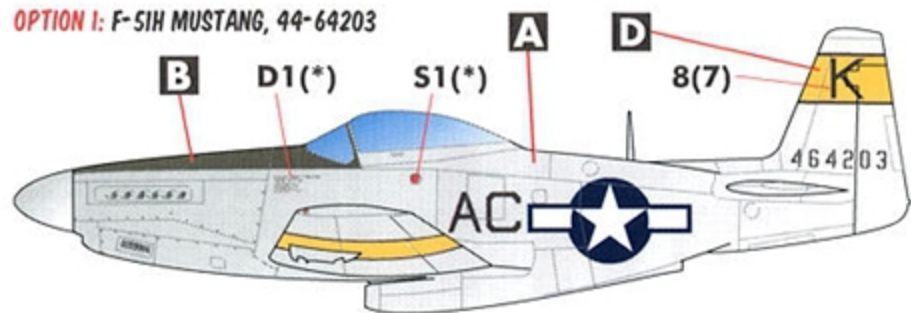

**THE FUEL CAP FILLER MARKING (S1) IS COMMON TO ALL OPTIONS**

**OPTION 2: F-51H MUSTANG, 44-64461**

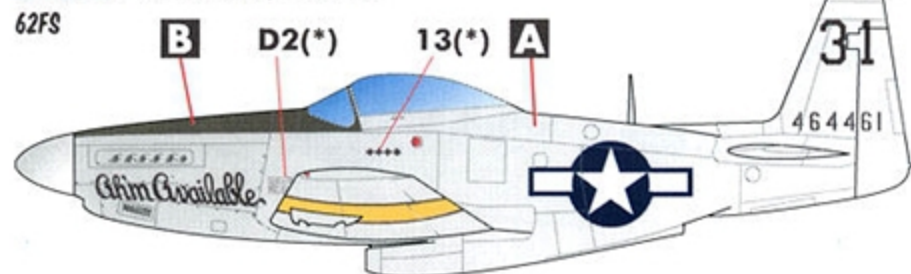

**WE BELIEVE THE "AHM AVAILABLE" ARTWORK WAS PAINTED IN BLACK. WE ARE NOT CERTAIN THOUGH, SO WE PROVIDE A RED ALTERNATIVE.**

**OPTION 3: F-51H MUSTANG, 44-64319**

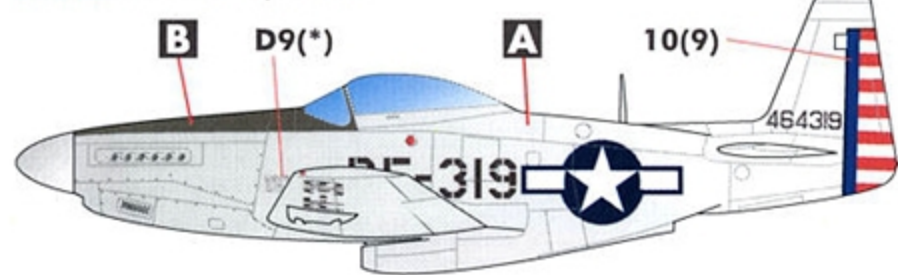

**USE THE "PF-319" ON THE MAIN SHEET FOR THE FUSELAGE SERIAL. PAINT THE RUDDER WHITE PRIOR TO DECAL APPLICATION.**

**OPTION 4: F-51H MUSTANG, 44-64633**

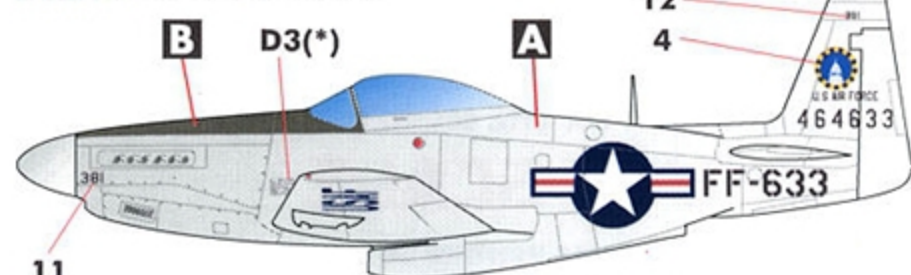

**FOR OPTIONS 4 TO 8, PLEASE APPLY THE SEPARATE RED STRIPES TO FORM THE POSTWAR US NATIONAL INSIGNIA.**

**OPTION 5: F-51H MUSTANG, 44-64675**

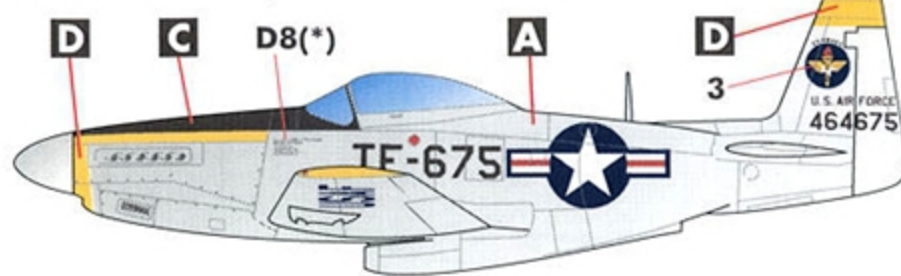

**OPTION 6: F-51H MUSTANG, 44-64346**

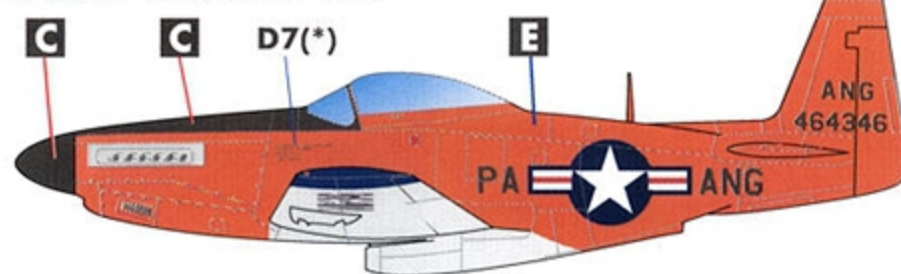

**OPTION 7: F-51H MUSTANG, 44-64350**

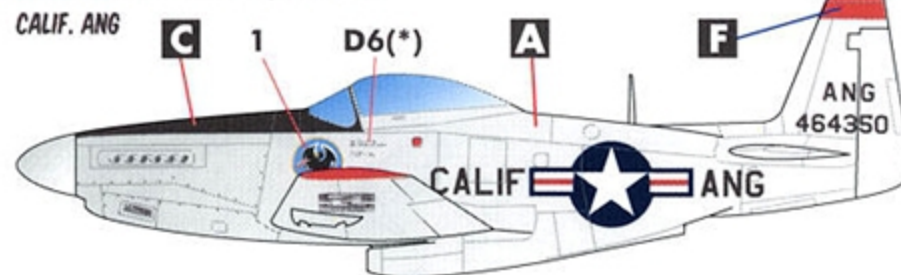

**OPTION 8: F-51H MUSTANG, 44-64505**

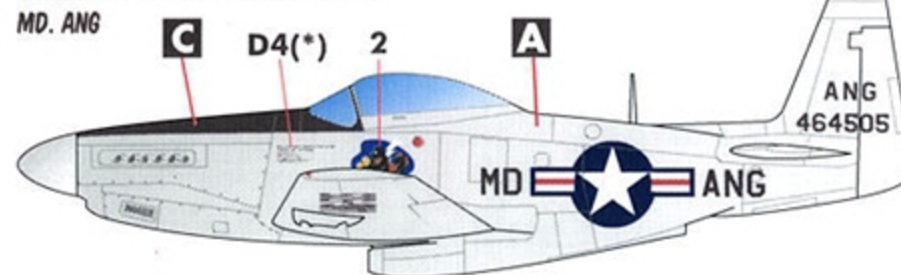

**OPTION 9: F-51H MUSTANG, 44-64415 "NACA 130"**

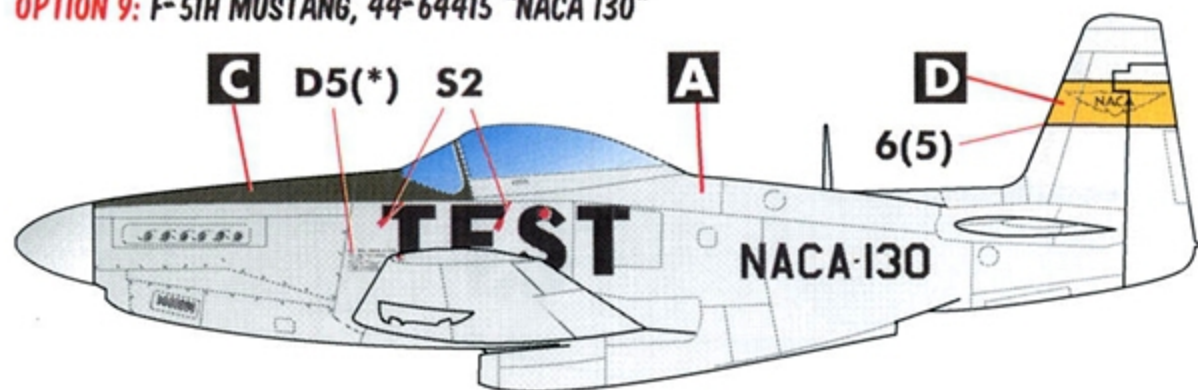

**THIS AIRCRAFT WAS BASED AT NACA AMES AERONAUTICAL LABORATORY AND SERVED UNTIL 1961**

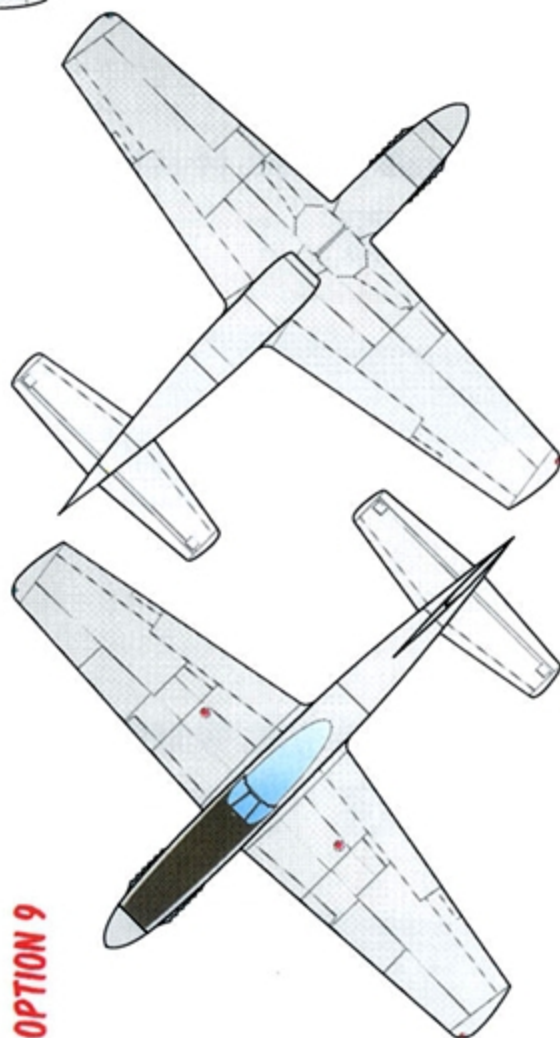
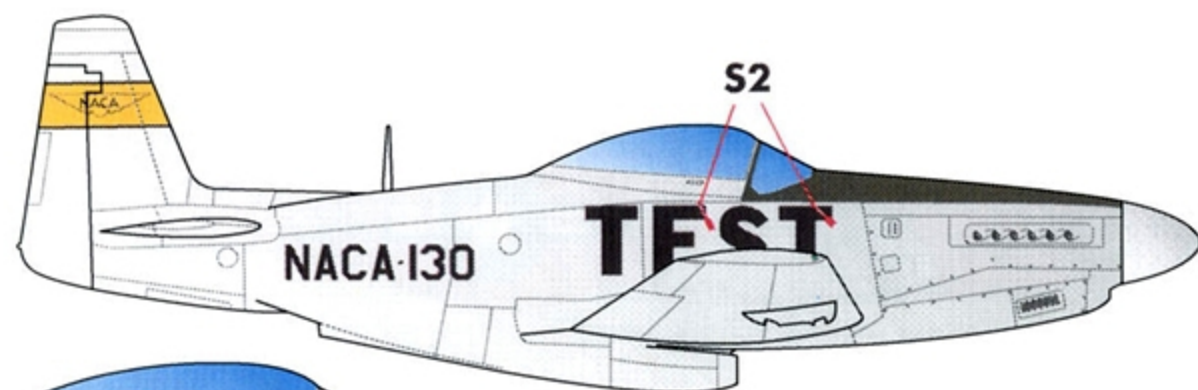

**OPTION 9**

- A** NATURAL METAL
- B** OLIVE DRAB (FS34087)
- C** FLAT BLACK (FS37038)
- D** CHROME YELLOW (FS33538)
- E** FLUORESCENT RED (FS28913)
- F** INSIGNIA RED (FS31136)
- G** INSIGNIA BLUE (FS35044)

**OPTIONS 1 & 2**

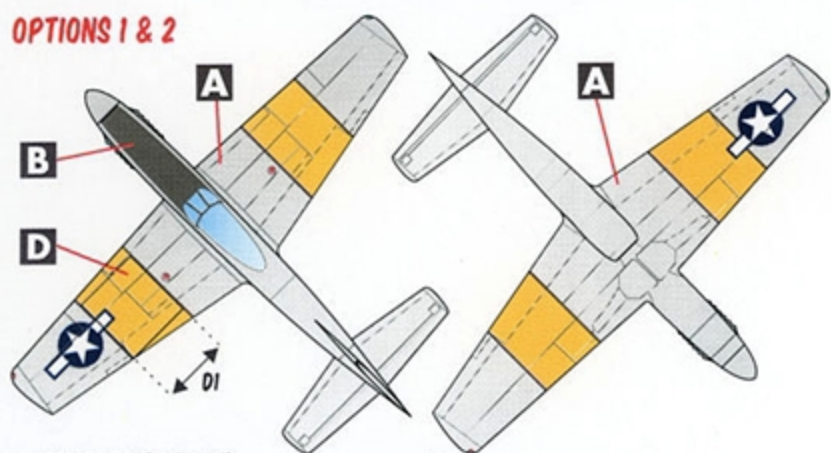

D1 = 1.25 IN (31.75 MM)

WE BELIEVE THE YELLOW STRIPES ON THE WINGS WERE 60 INCHES WIDE ON THE ACTUAL AIRCRAFT. USE THE BLACK STRIPES PROVIDED FOR THE BORDERS.

**OPTION 3**

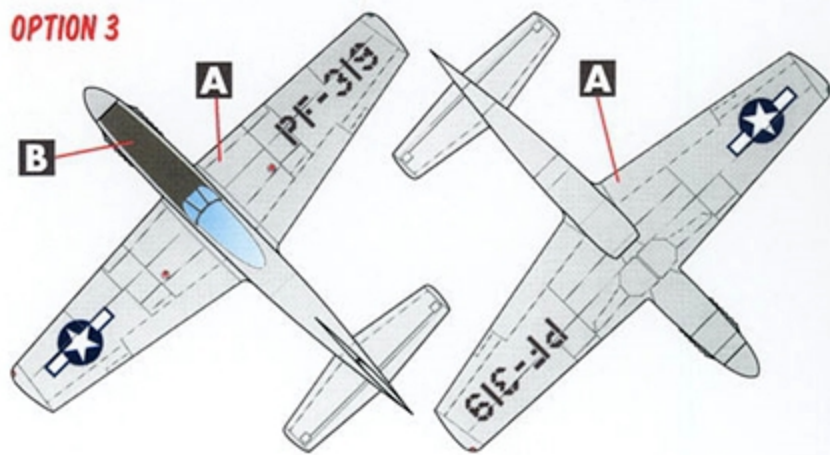

**OPTION 4**

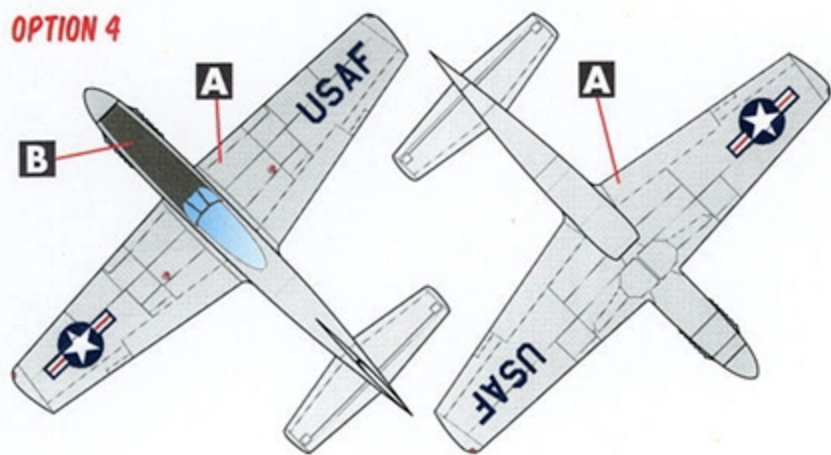

**OPTION 5**

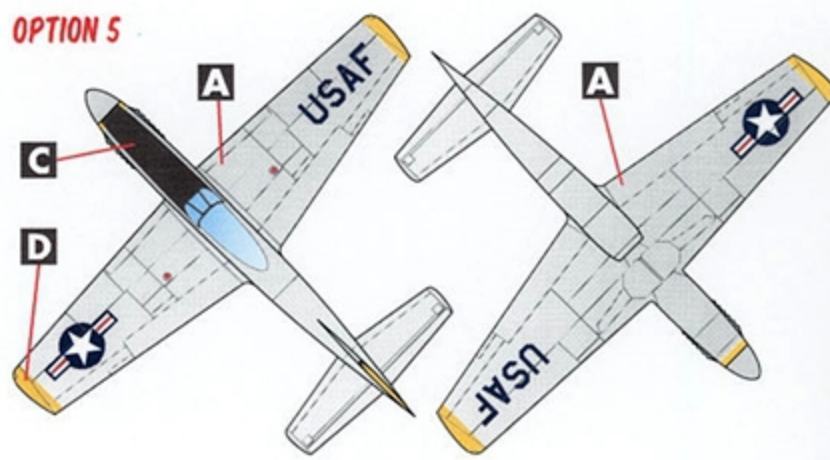

**OPTION 6**

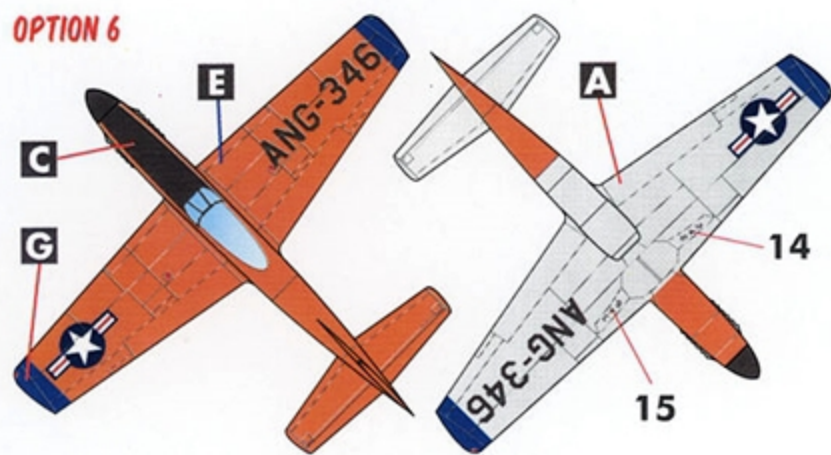

**OPTION 7**

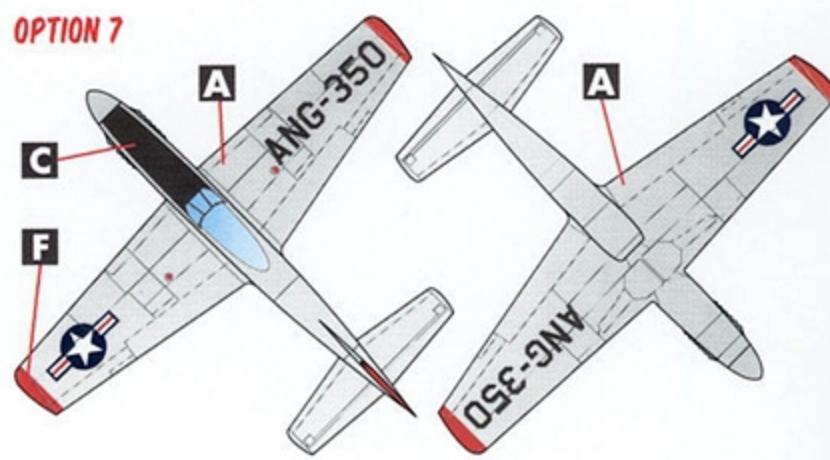

**OPTION 8**

