

**MATCHBOX**®

1-72nd  
SCALE  
KIT  
**WESTLAND LYSANDER**



**2**  
COLOUR  
KIT

Lysanders of 16 Squadron attacking  
a German Motorised Unit advancing  
on Dunkirk in May 1940.

"MATCHBOX" IS THE REG'D TRADE MARK (MARCA REGISTRADA) OF LESNEY PRODUCTS & CO. LTD. LONDON, ENGLAND

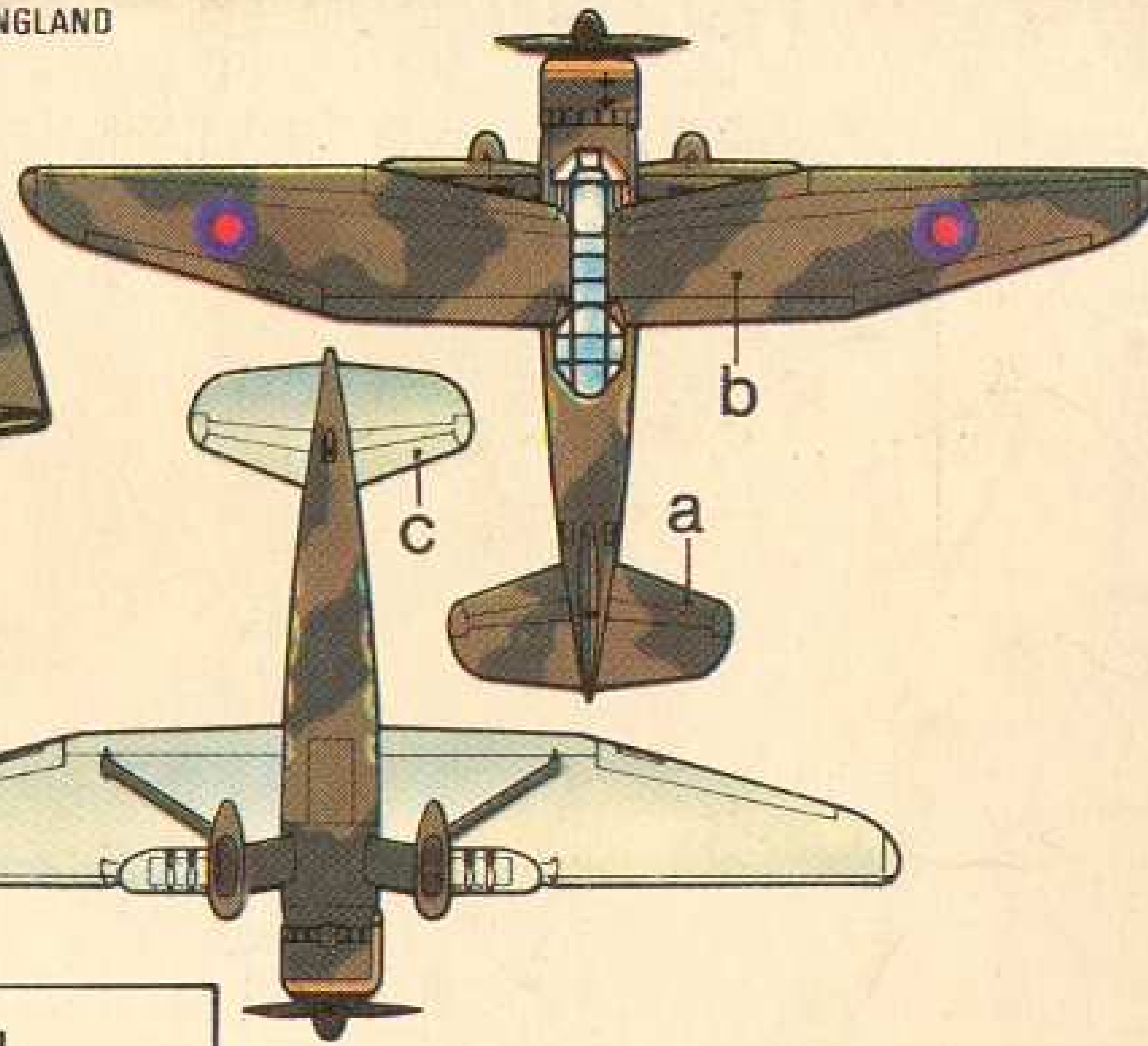

🇬🇧 This "LYSANDER" kit is quality engineered in two colours. Decals feature R.A.F. 16 Squadron or R.A.F. 225 Squadron. A full "Colour-Plan" and easier Mini-Paint plan are provided. For paint colours, see instruction leaflet.

**1** R.A.F. No. 16 Squadron  
FRANCE 1940.

	<b>MATCHBOX</b>	COLOUR PLAN
	<b>WESTLAND LYSANDER</b>	PLANCHE EN COULEURS
		FARBPLAN
		PLAN DE COLORES
		SCHEMA DEI COLORI

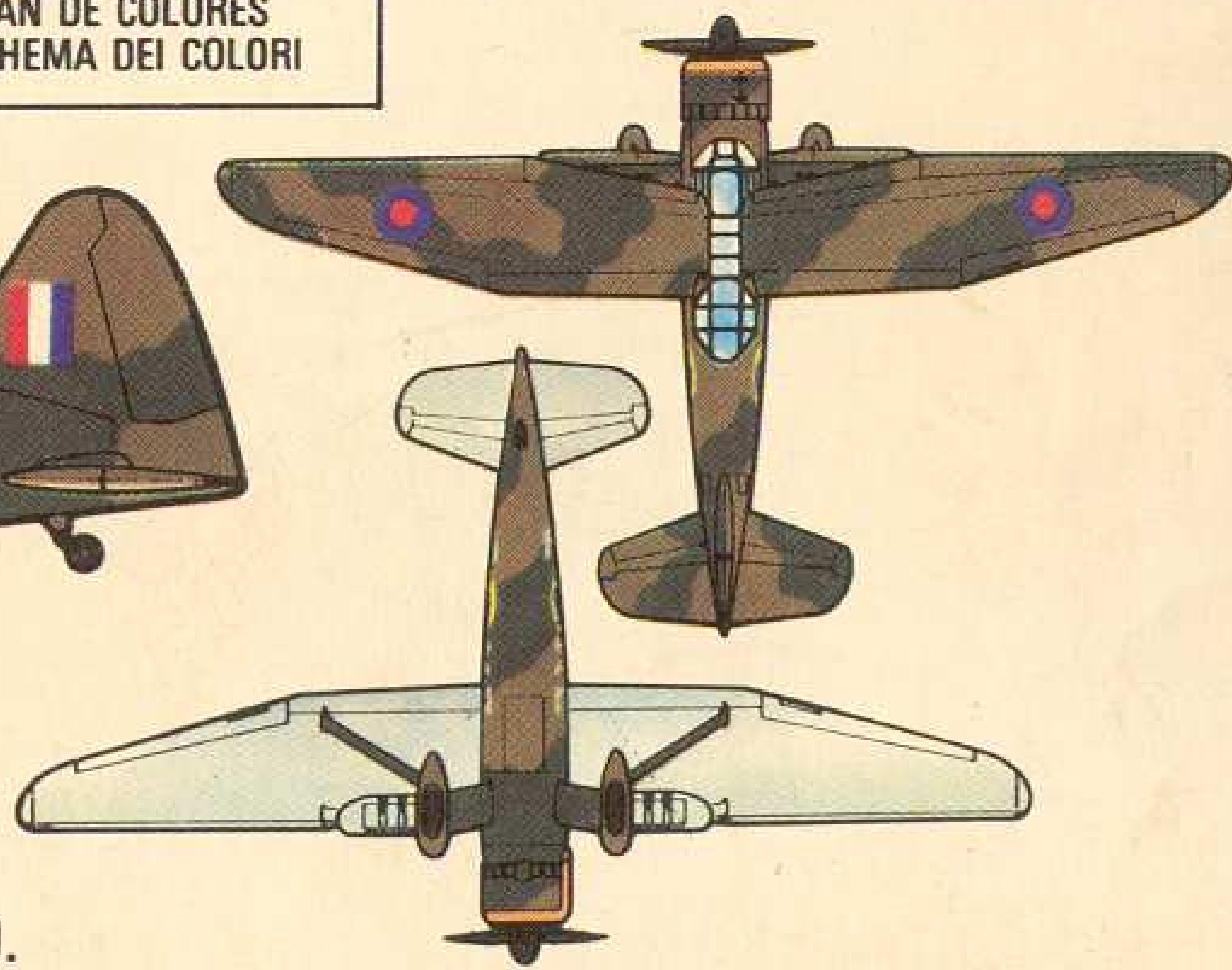
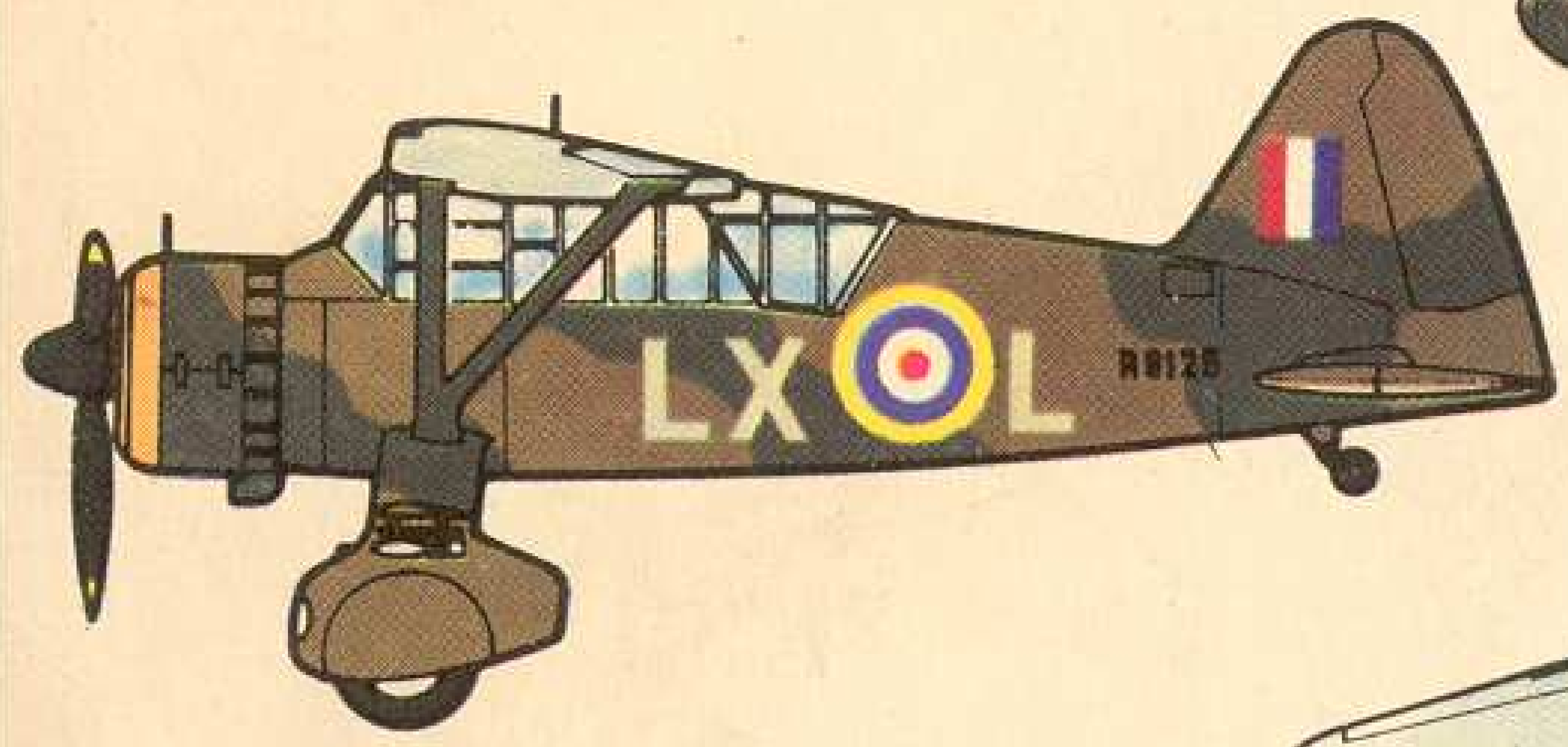

**2** R.A.F. No. 225 Squadron  
formed ODIHAM Oct. 3rd, 1939.

CONTENTS: Parts and decals necessary to construct model as illustrated. Cement not included. SPECIFICATION AND COLOUR OF CONTENTS SUBJECT TO AMENDMENTS

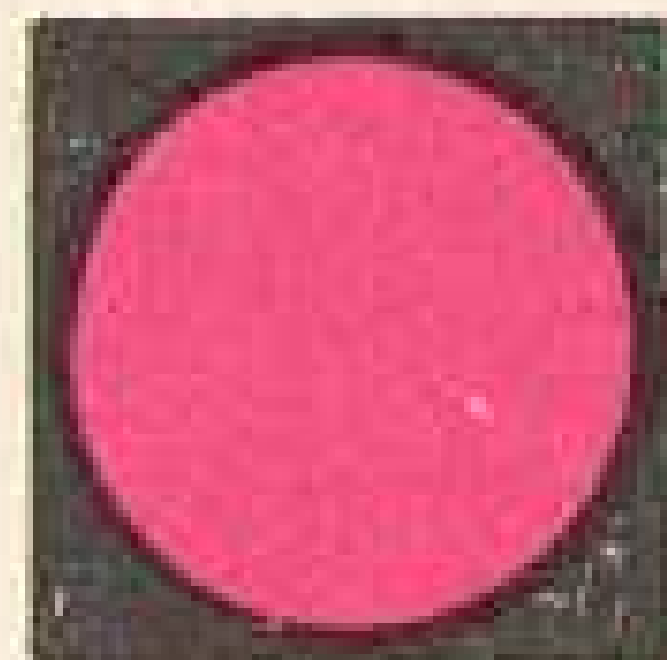

**"MATCHBOX"®**

1-72nd  
SCALE  
KIT

# WESTLAND LYSANDER

Designed by W.E.W. Petter in 1935 as an Army Co-operation Machine, the aircraft had a remarkable performance and was able to operate fully loaded from an area the size of a football field, and also fly as slowly as 55 m.p.h. (88 km/h). Lysanders served in Burma, the Western Desert, Europe etc., and were in France in September 1939. They were also used for air/sea rescue duties, and later for flying agents into occupied Europe. The Mk. II Machine as depicted was powered by the Bristol PERSEUS sleeve valve engine and other marks were fitted with the Mercury engine.

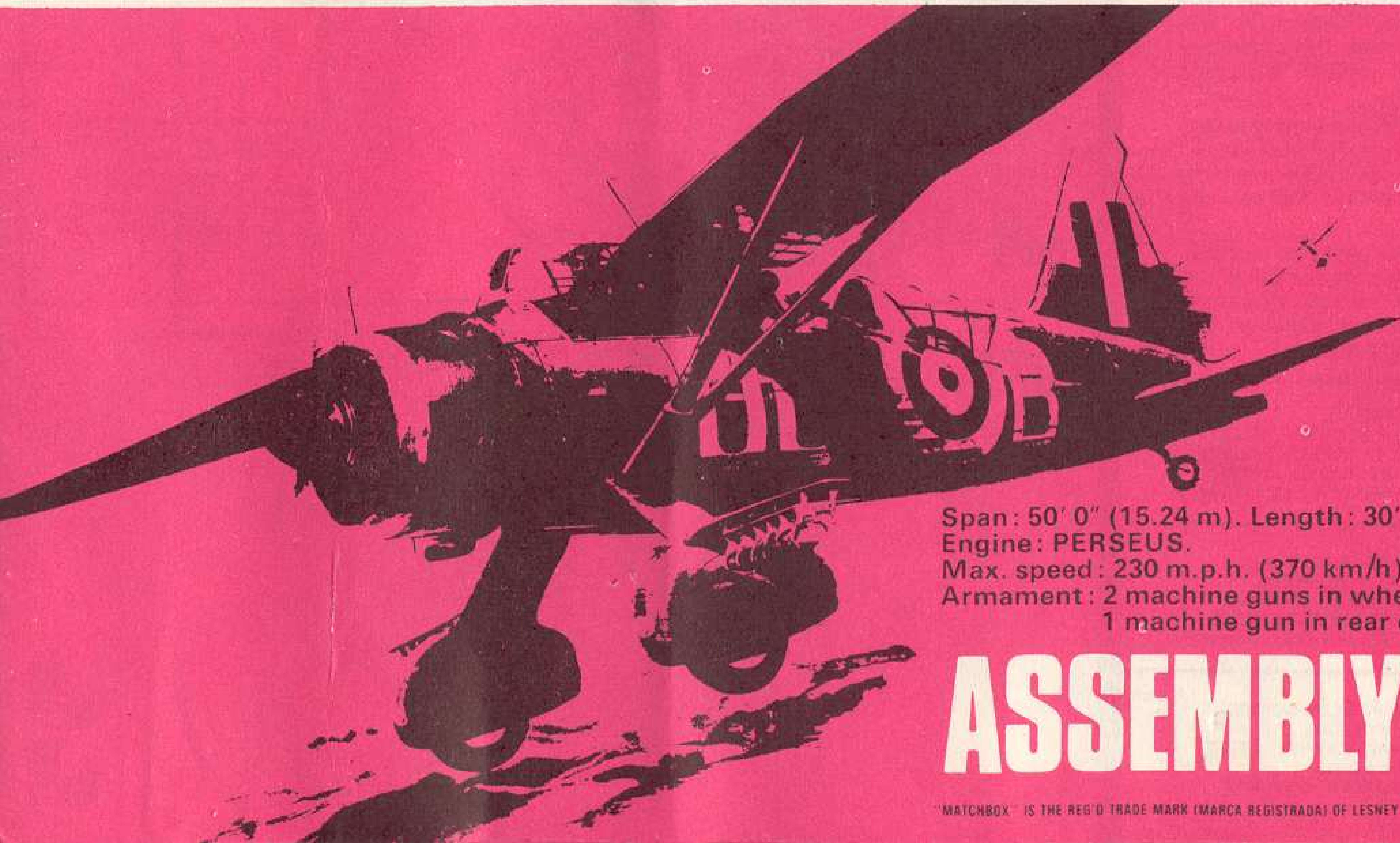

Span: 50' 0" (15.24 m). Length: 30' 6" (9.29 m).  
Engine: PERSEUS.  
Max. speed: 230 m.p.h. (370 km/h).  
Armament: 2 machine guns in wheel spats  
1 machine gun in rear cockpit.

**ASSEMBLY** MONTAGE  
MONTAGE MONTAGGIO  
MONTAJE

"MATCHBOX" IS THE REG'D TRADE MARK (MARCA REGISTRADA) OF LESNEY PRODUCTS & CO. LTD. LONDON, ENGLAND.

### Paint Plans:

"MATCHBOX" Kits are quality engineered in two colours so that no painting is necessary to obtain a really finished model. However should you wish to paint your model, two paint plans are available.

**Mini-Paint Plan** (on bottom box ends):

Since "MATCHBOX" Kits are moulded in two colours an impressive result can be obtained by painting only certain parts of the Kit. Just paint the parts shown in the Mini-Paint Plan.

**Full Colour Paint Plan** (on bottom of box):

Follow this plan for a completely authentic colour detail model.

The paint plans and decals included with all "MATCHBOX" Kits give a choice of two squadrons or liveries.

**USE ONLY PROPRIETARY BRANDS OF MODEL PAINT.**

### Planches a colorier:

Les kits "MATCHBOX" sont présentés en plastique moulé en deux couleurs de sorte que pour obtenir un modèle tout à fait fini aucun coloriage n'est nécessaire. Toutefois, si on désire colorier le kit, deux planches à colorier sont disponibles.

**La miniplanche à colorier:** (sur les bords du fond de la boîte): Etant donné que les kits "MATCHBOX" sont moulés en deux couleurs, un résultat remarquable peut être obtenu en coloriant seulement certaines parties du kit, comme il est indiqué sur la miniplanche.

**Planche à colorier complète** (sur le fond de la boîte):

Suivre les indications détaillées de cette planche pour obtenir un modèle en couleurs tout à fait exact.

Les planches à colorier et les décalcomanies fournies avec tous les kits "MATCHBOX" permettent de choisir entre deux escadrons ou emblèmes.

**UTILISER UNIQUEMENT DES PEINTURES MELANGÉES SPECIALEMENT POUR MODELES EN PLASTIQUE.**

### Farbpläne

Die "MATCHBOX"-Modellsätze sind in zwei Farben technisch einwandfrei hergestellt, so daß kein Anstrich für ein Modell mit ausgezeichneter Oberflächenausführung erforderlich ist. Falls Sie jedoch Ihr Modell anstreichen wollen, so sind zwei Farbpläne erhältlich.

**Mini-Farbplan** (an den Enden der Schachteln):

Da die "MATCHBOX"-Modellsätze in zwei Farben geformt werden, kann ein ausgezeichnetes Resultat durch Anstreichen von gewissen Teilen des Modellsatzes erzielt werden. Streichen Sie nur die im Mini-Farbplan angegebenen Teile an.

**Vollständiger Farbplan** (auf der Unterseite der Kästen):

Folgen Sie diesem Plan, um ein in allen Farbeinheiten authentisches Modell anzufertigen. Die allen "MATCHBOX"-Modellsätzen beiliegenden Farbpläne und Abziehbilder gestatten eine Auswahl von zwei Staffelabzeichen oder Signets.

**NUR MARKENANSTRICHMITTEL FÜR MODELLE VERWENDEN.**

### Schemi di colorazione:

I kit "MATCHBOX" sono superbamente realizzati in due colori, perciò non occorre dipingerli per ottenere un modello finito. Tuttavia, se desiderate dipingere il vostro modello, ci sono due schemi di colorazione.

**Schema di colorazione "Mini"** (sulle estremità della scatola senza coperchio):

Dato che i kit "MATCHBOX" sono realizzati in due colori, si può ottenere un effetto stupendo con la colorazione di solo alcuni pezzi. Dipingere solamente i pezzi indicati nello schema di colorazione "Mini".

**Schema di colorazione generale:** (sul fondo della scatola).

Seguire questo schema per ottenere una versione colorata assolutamente autentica.

Gli schemi di colorazione e le decalcomanie contenute in tutti i kit "MATCHBOX" permettono la scelta di due squadriglie o emblemi.

**ADOPERARE SOLTANTO VERNICI DI MARCA PER MODELLI.**

### Planes de Pintura:

Los equipos "MATCHBOX" son de concepción técnica de calidad en dos colores de modo que no se necesita pintura para lograr un modelo realmente acabado. No obstante si desea pintar su modelo, puede disponer de dos planes de pintura.

**Plan de Pintura Mínima** (en los extremos de la caja):

Puesto que los Equipos "MATCHBOX" están moldeados en dos colores, puede obtenerse un resultado impresionante pintando solamente ciertas partes del equipo. Pinte tan solo las partes indicadas en el Plan de Pintura Mínima.

**Plan de Pintura a Todo Color:** (en el fondo de la caja)

Siga este plan para un modelo con detalle de colores completamente auténtico. Los planes de pintura y calcomanías incluidos en todos los equipos "MATCHBOX" permiten elegir entre dos escuadrillas o emblemas.

**USE SOLAMENTE MARCAS DE PATENTE DE PINTURA PARA MODELOS.**

Models available:

Modèles disponibles:

Erhältliche Modelle:

Modelli disponibili:

Modelos disponibles:

**PK-1 HAWKER FURY • PK-2 SPITFIRE MK.IX • PK-3 BOEING P-12.E • PK-4 MITSUBISHI ZERO-SEN  
PK-5 DORNIER DASSAULT ALPHA JET • PK-6 FOCKE-WULF FW.190 • PK-7 WESTLAND LYSANDER  
PK-8 GLOSTER GLADIATOR • PK-9 BELL HUEY-COBRA • PK-10 B.A.C. 167 STRIKEMASTER  
PK-11 HAWKER HURRICANE • PK-12 NORTHROP F5-A • PK-13 MUSTANG P51-D • PK-14 CORSAIR F4U-4  
PK-15 GNAT T. MK.I • PK-16 HAWKER HARRIER • PK-17 MESSERSCHMITT 109E • PK-18 GRUMMAN  
HELLCAT • PK-19 MIKOYAN MIG-21 • PK-20 DASSAULT MIRAGE 111C**

*Other models to follow*

# HOT HINTS

GUIDE TO BETTER MODELING

GUIDE POUR UN MEILLEUR MODELAGE  
ANLEITUNG ZUM BESSEREN MODELLBAU  
GUIDA PER UNA MIGLIORE MODELLISTICA  
GUIA PARA UN MEJOR MODELADO

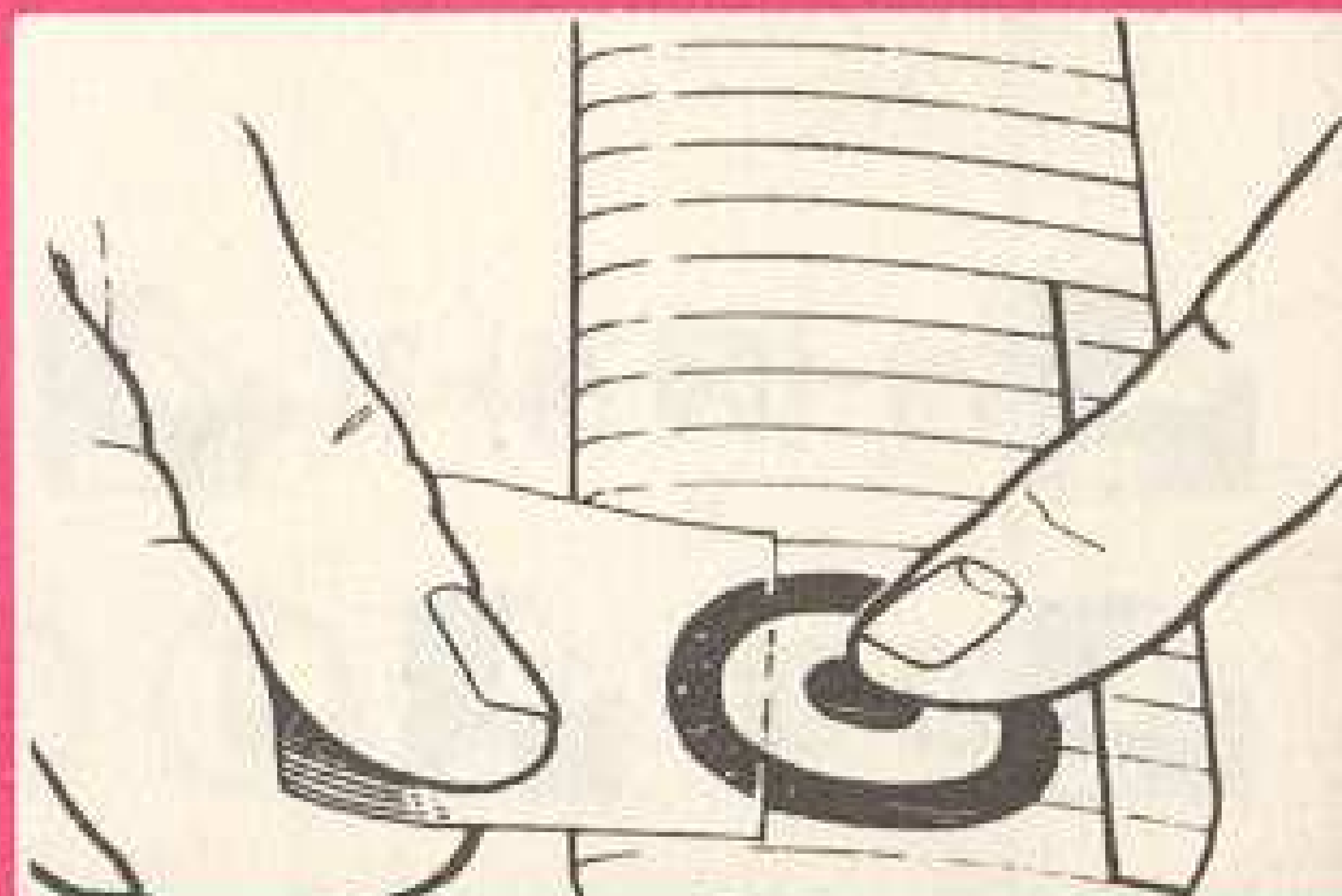
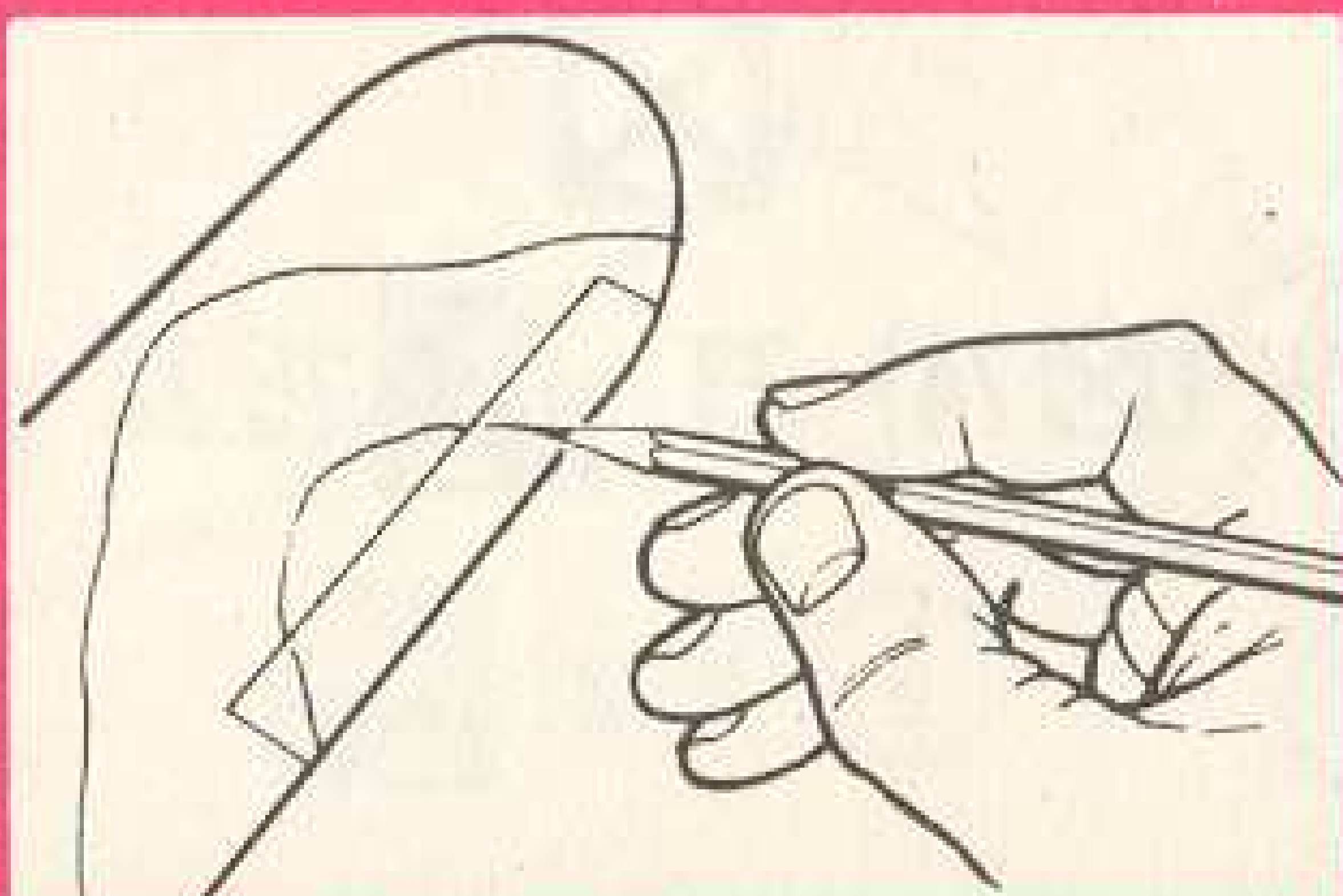
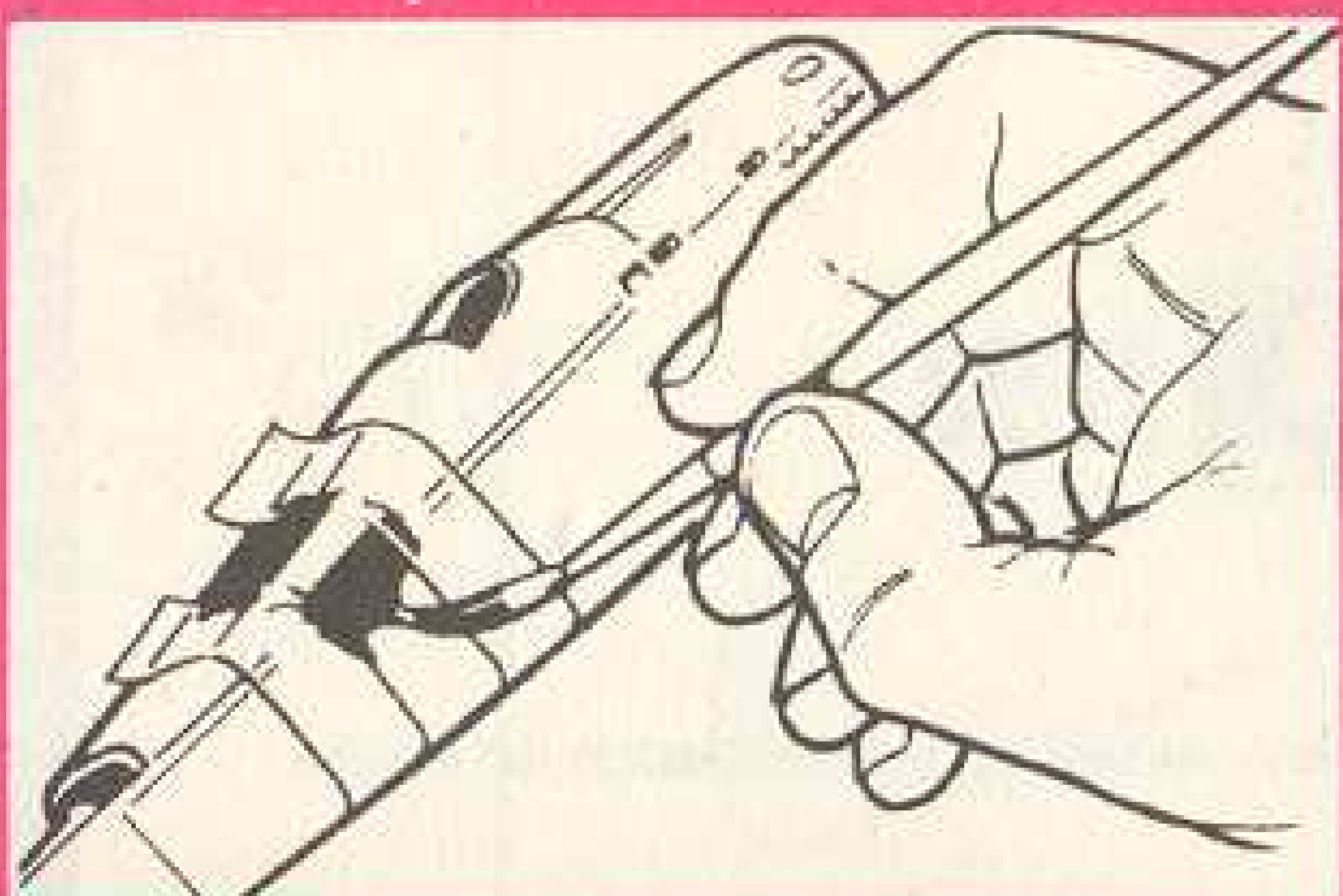
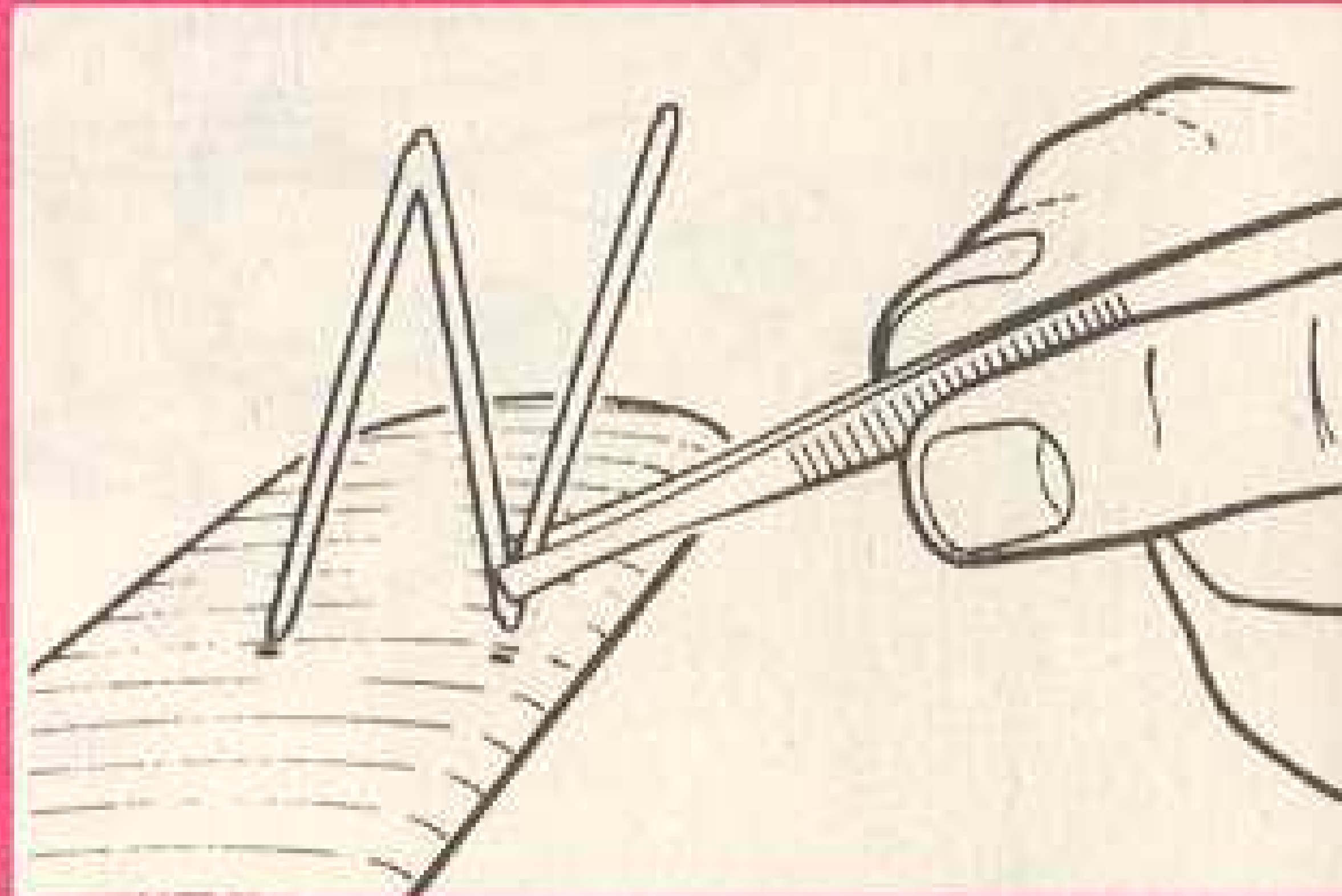
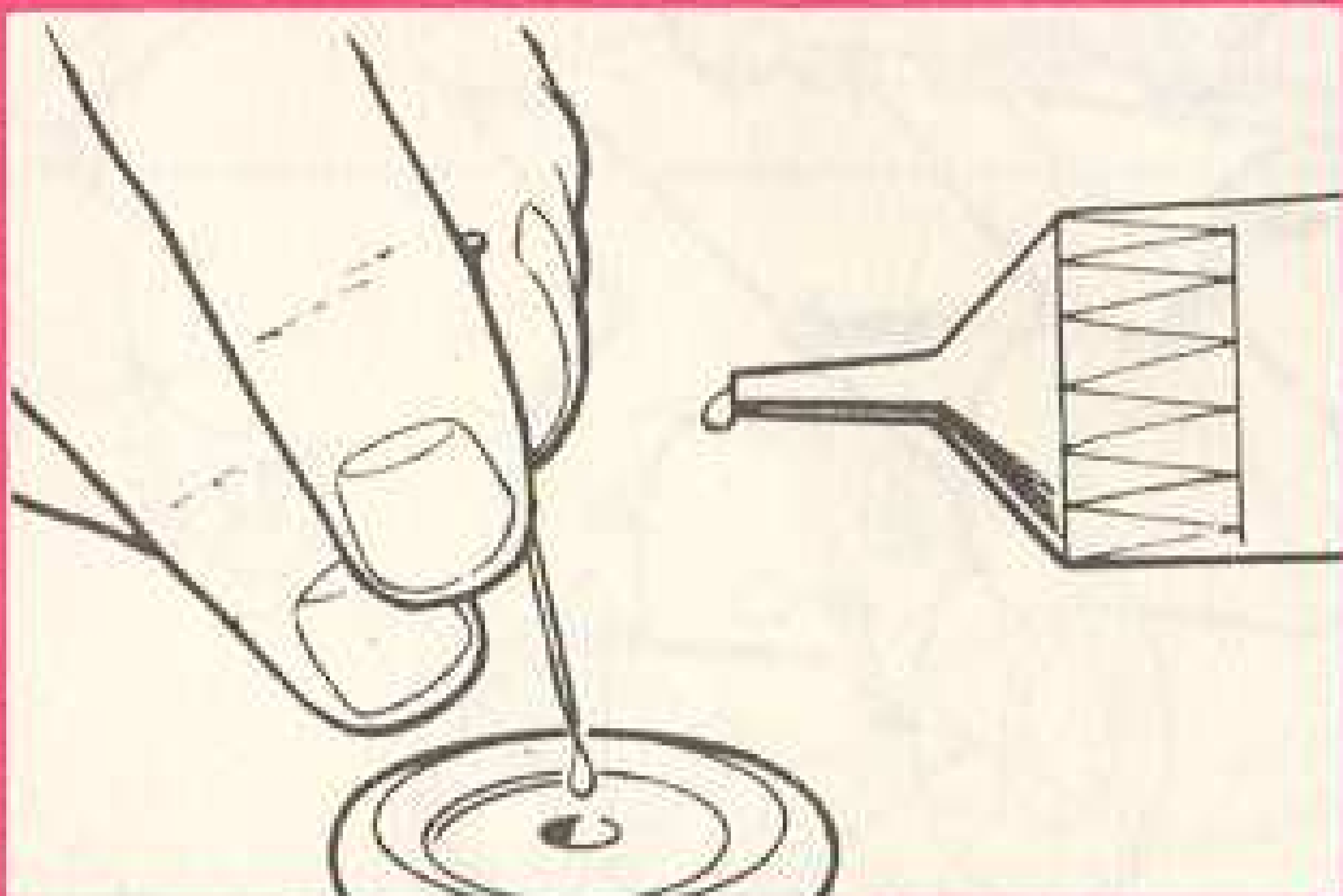
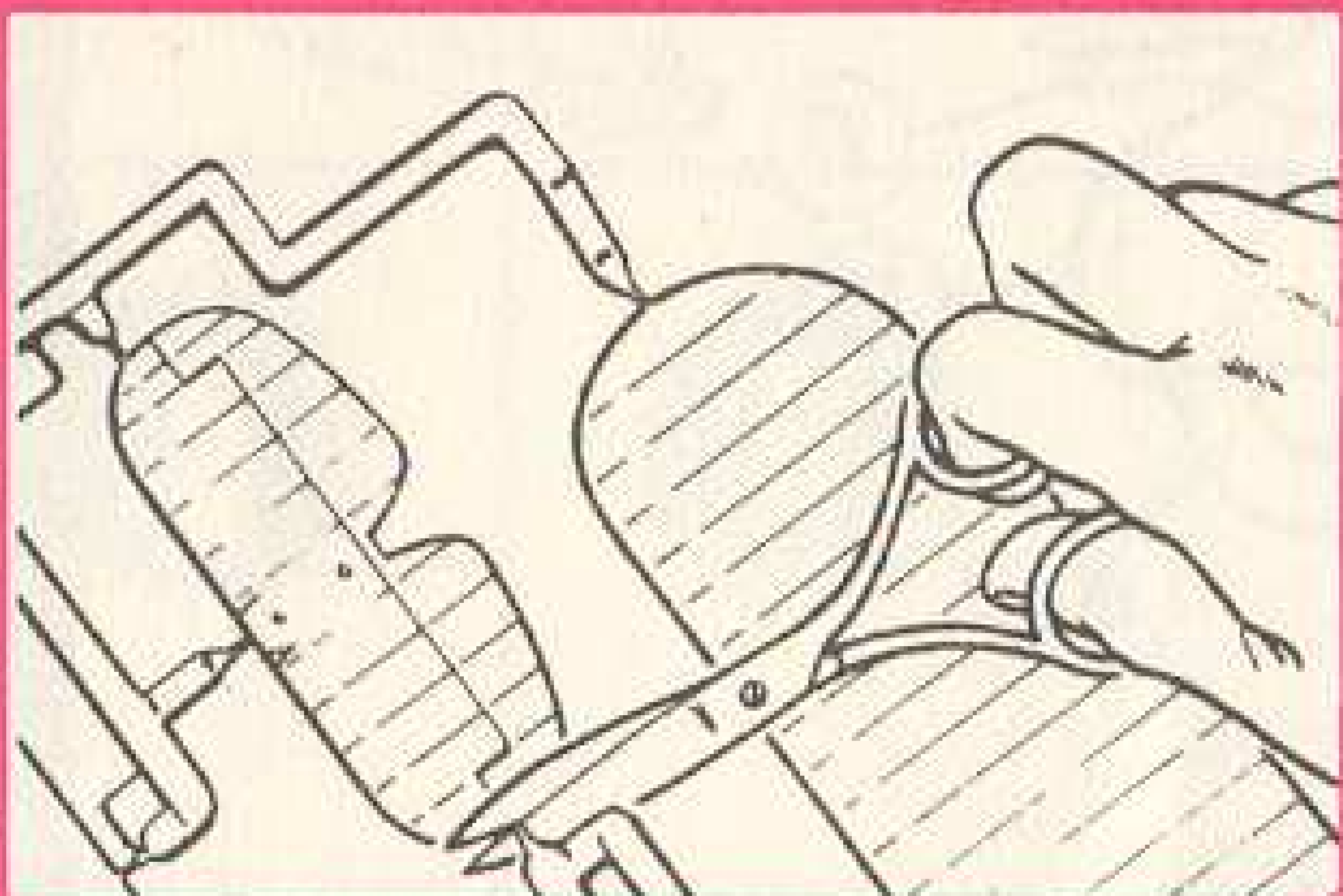
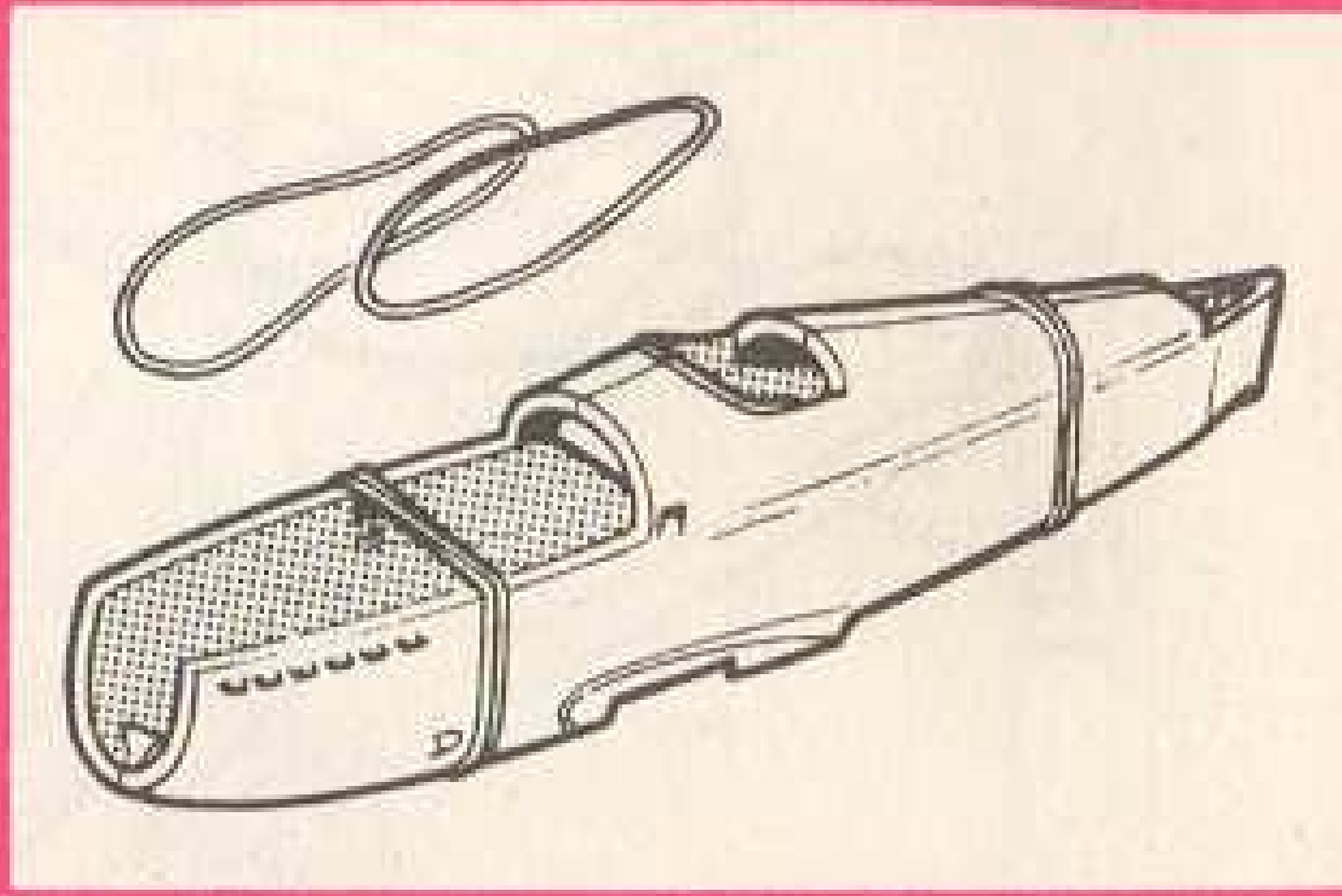
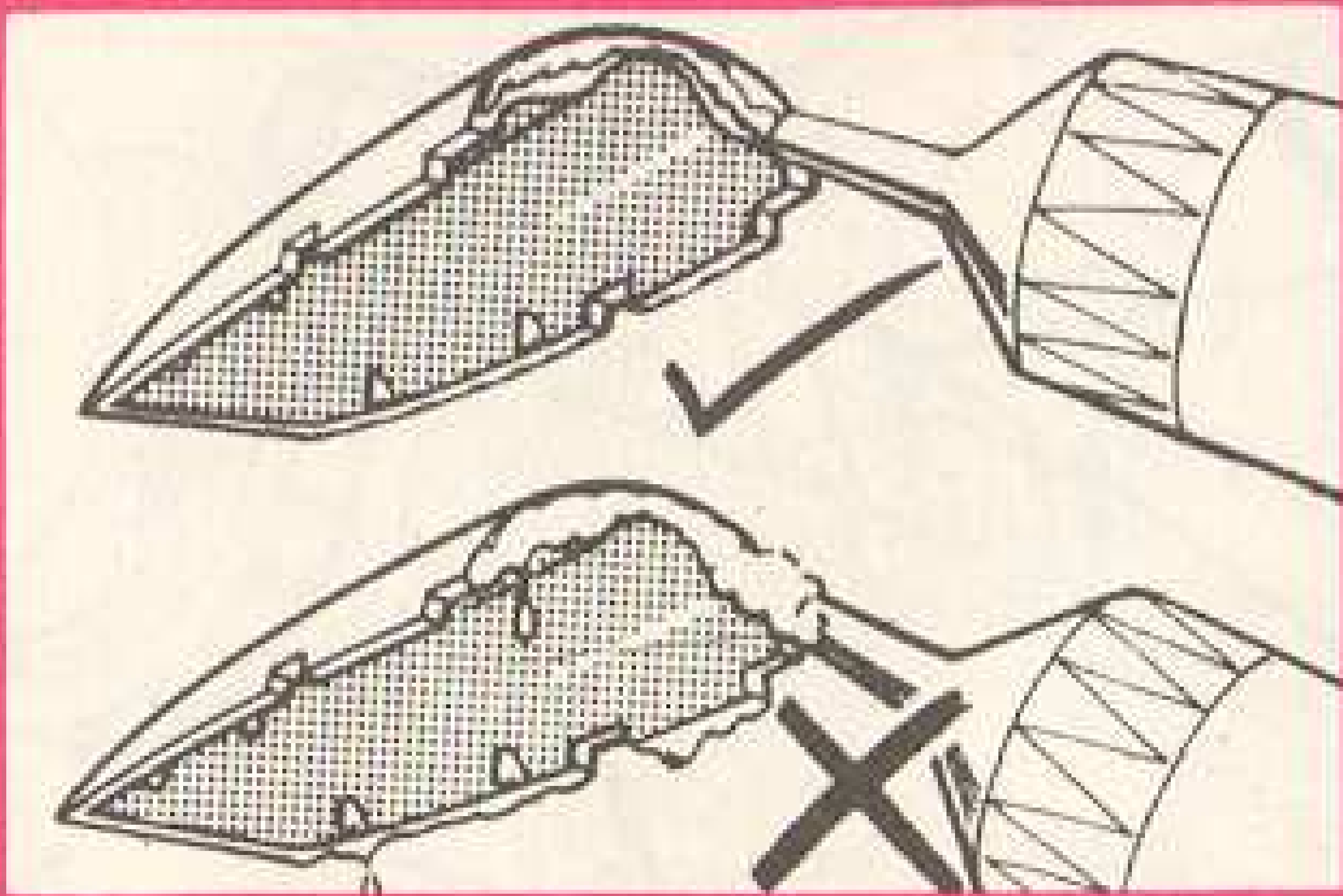
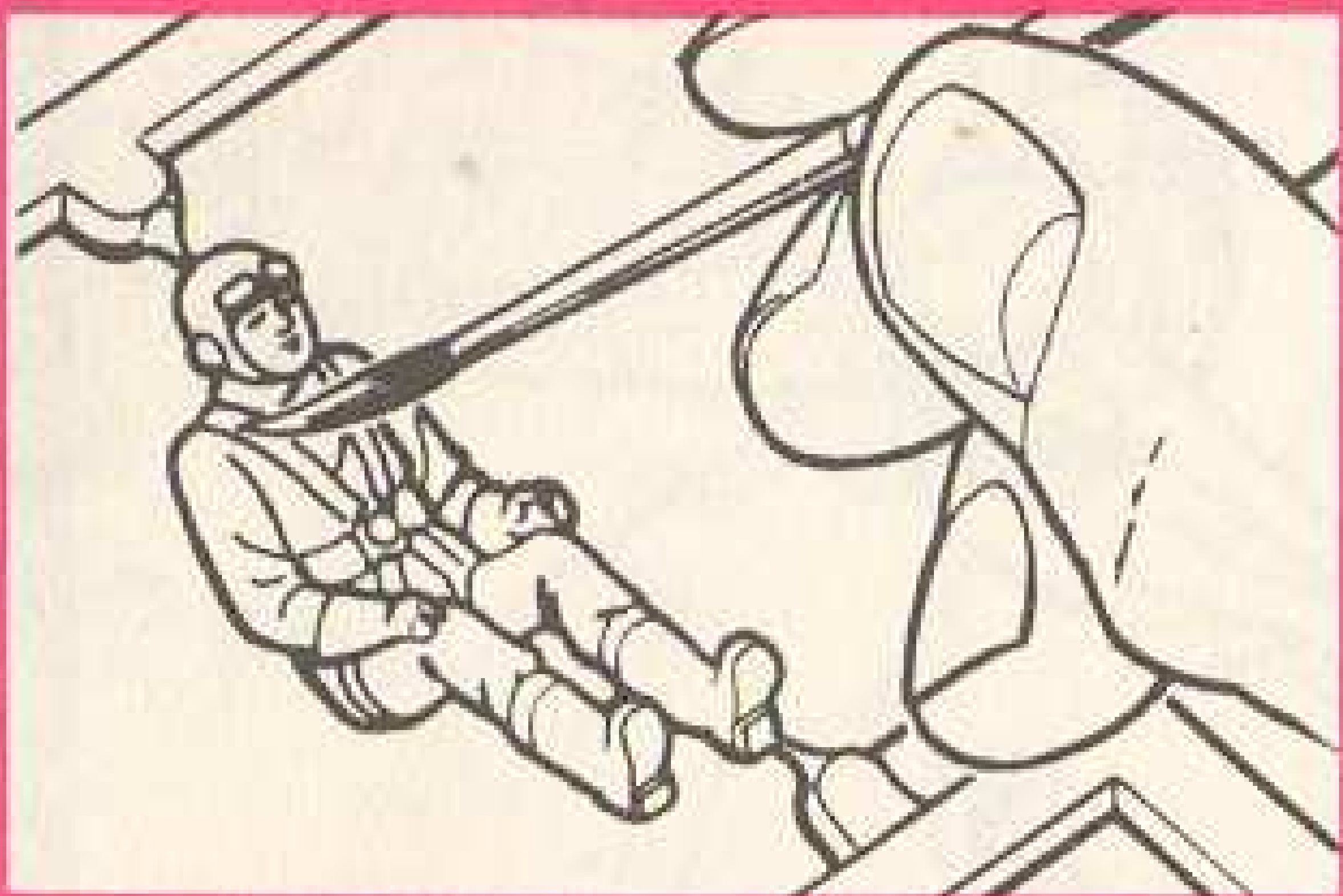

MY COMPLAINT IS. L'OBJET DE MA RECLAMATION EST.  
ICH BEMÄNGELE. DASS OGGETTO DEL RECLAMO.  
MI RECLAMACION ES.

MY ADDRESS. MON ADRESSE EST LA SUIVANTE.  
MEINE ADRESSE. IL MIO INDIRIZZO MI DIRECCION.

RETURN TO (UK ONLY)  
CONSUMER SERVICE DEPT.  
LESNEY PRODUCTS & CO. LTD.  
SWAINS INDUSTRIAL ESTATE,  
ASHINGDON ROAD,  
ROCHFORD, ESSEX, ENGLAND.

NAME OF KIT DENOMINATION DU KIT  
MODELSATZ-BEZEICHNUNG NOME DEL KIT  
NOMBRE DEL EQUIPO

Paint required parts before assembly. Assemble parts in sequence. Black numbers in circle indicate part number. Black numbers in star indicate completed section.

Peindre les pièces comme vous le désirez avant le montage. Monter les pièces dans l'ordre numérique. Les chiffres noirs encadrés indiquent le numéro de la pièce. Les chiffres noirs en étoile indiquent une section complète.

Die erforderlichen Teile vor dem Zusammenbau streichen. Die Teile in der richtigen Reihenfolge montieren. Die schwarzen Ziffern in den Kreisen sind die Teilnummern. Die schwarzen Ziffern in den Sternen zeigen komplette Baugruppen an.

Dipingere i pezzi occorrenti prima del montaggio. Montare i pezzi in ordine numerico. I numeri neri in un cerchio indicano il numero del pezzo. I numeri neri in una stella indicano una sezione completa.

Pintar las piezas requeridas antes del montaje. Montar las piezas en secuencia numérica. Los números negros en un círculo indican el número de pieza. Los números negros en una estrella indican una sección completa.



**CEMENT PARTS**  
 ENDUIRE LES PIÈCES DE COLLE  
 TEILE MIT KLEBSTOFF BESTREICHEN  
 APPLICARE ADESIVO SUI PEZZI  
 PONER ADHESIVO EN LAS PIEZAS



**DO NOT CEMENT TOGETHER**  
 NE PAS COLLER ENSEMBLE  
 NICHT ZUSAMMENKLEBEN  
 NON ATTACCARE CON ADESIVO  
 NO UNIR LAS PIEZAS CON ADHESIVO

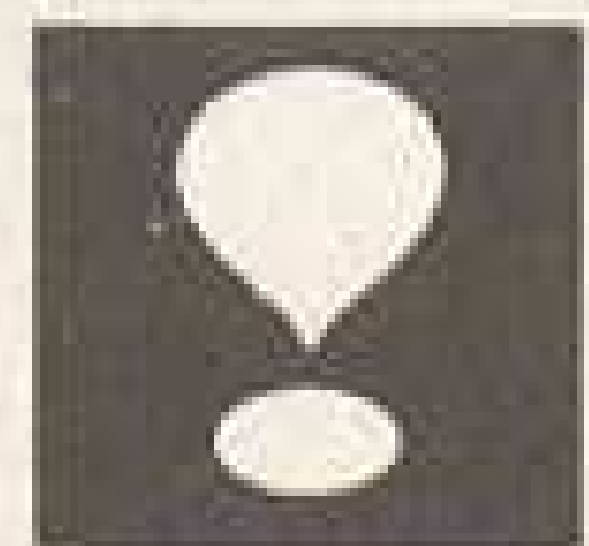

**ALTERNATIVE PART PROVIDED**  
 PIÈCE AUTRE FOURNIE  
 WAHLWEISE MIT ANDEREM TEIL  
 PEZZO ALTERNATIVO  
 PIEZA ALTERNATIVA PROVISTA

**1**

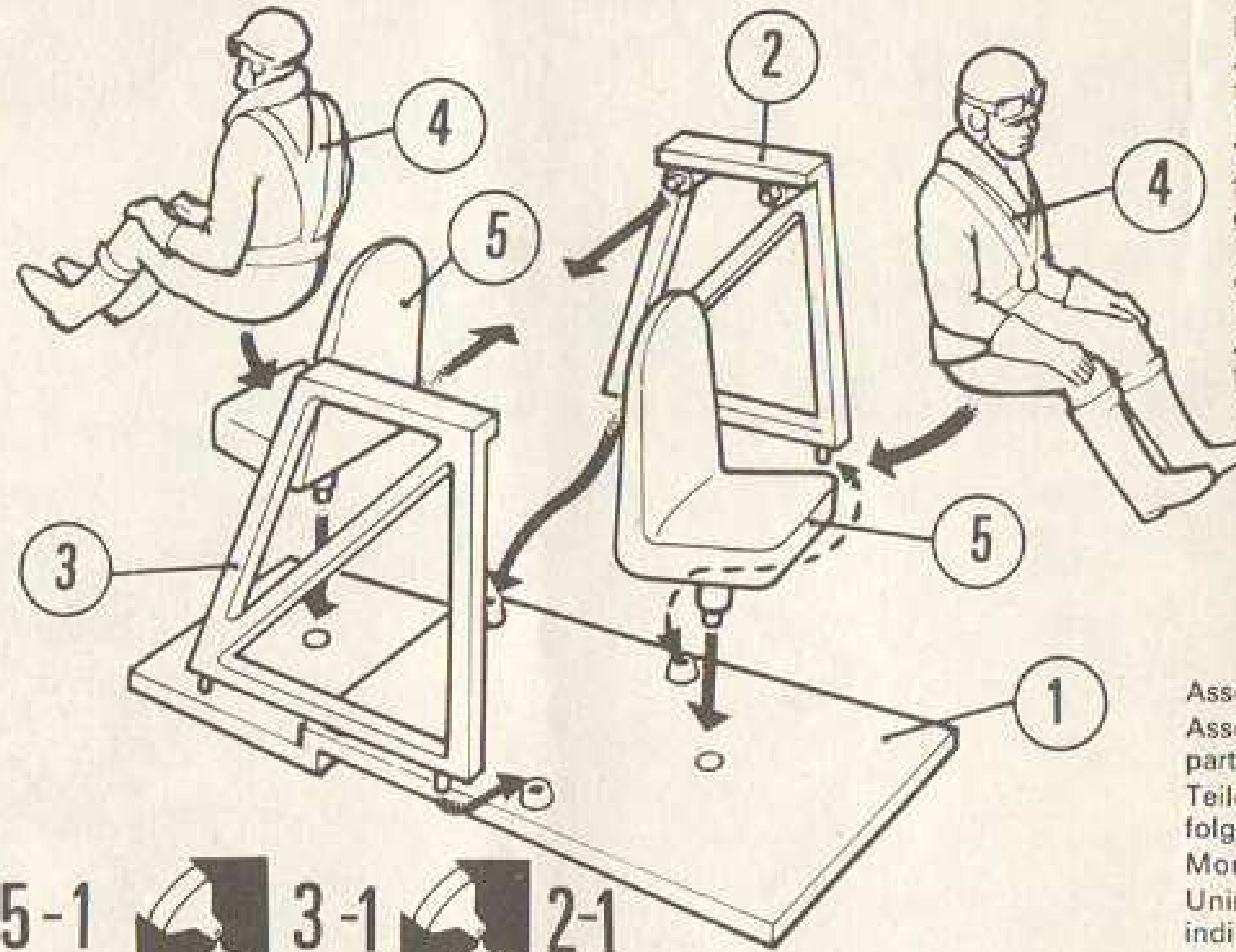

Before joining fuselage halves clear holes 'A' (when shown).  
 Avant de joindre les deux moitiés du fuselage, dégager les trous 'A' (quand ils sont indiqués).  
 Vor Zusammensetzung der Rumpfhälften, Löcher 'A' säubern (falls gezeigt).  
 Prima di congiungere le due metà della fusoliera, pulite i buchi 'A' (quando sono indicati).  
 Antes de unir las dos mitades del fuselaje, despeje las cavidades 'A' (cuando están indicadas).

Assemble parts in sequence shown  
 Assembler par collage les différentes parties selon l'ordre indiqué  
 Teile in der angegebenen Reihenfolge zusammenkleben  
 Montare i pezzi nell'ordine indicato  
 Unir las piezas en la secuencia indicada

**4**

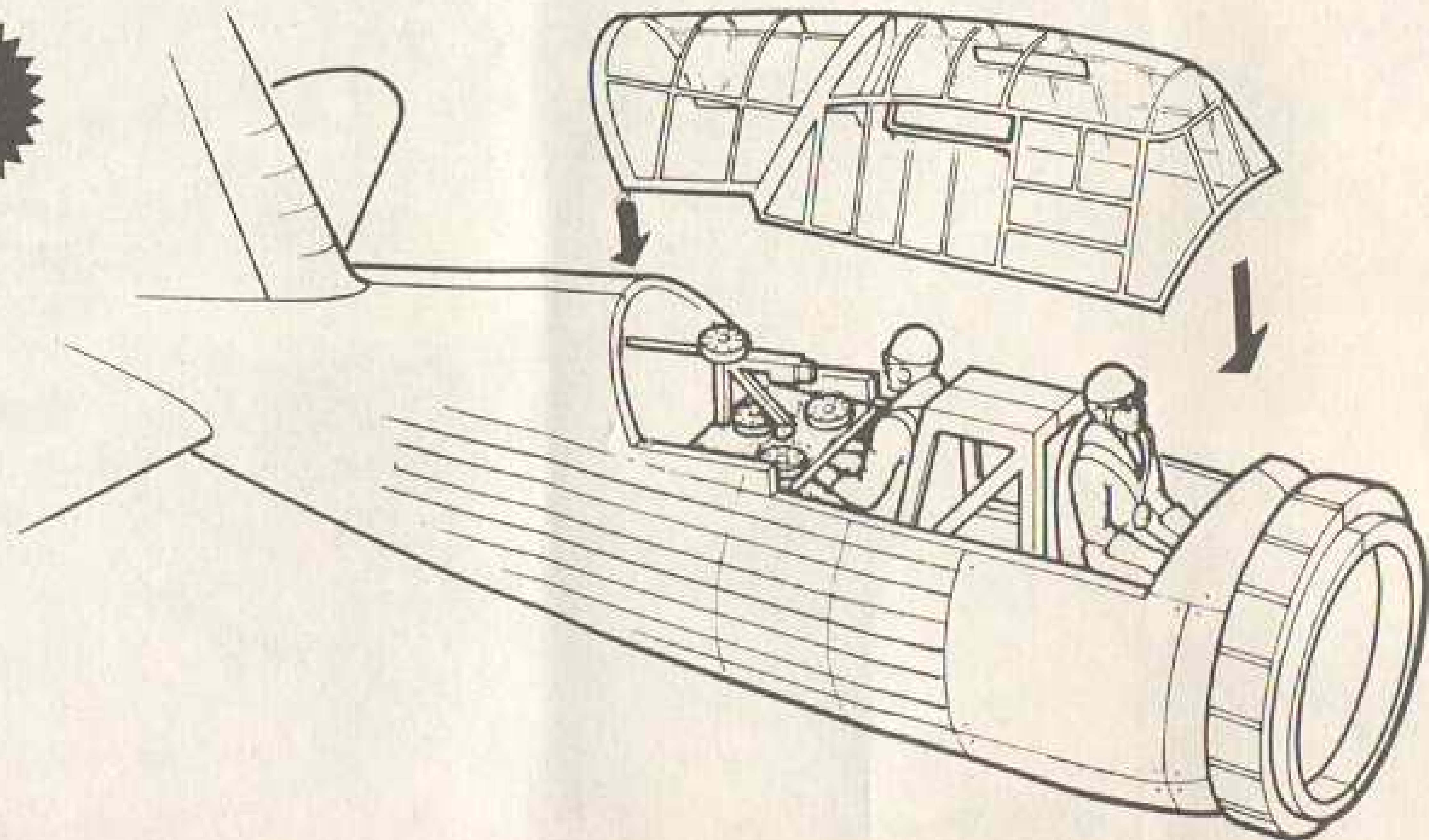

12



15

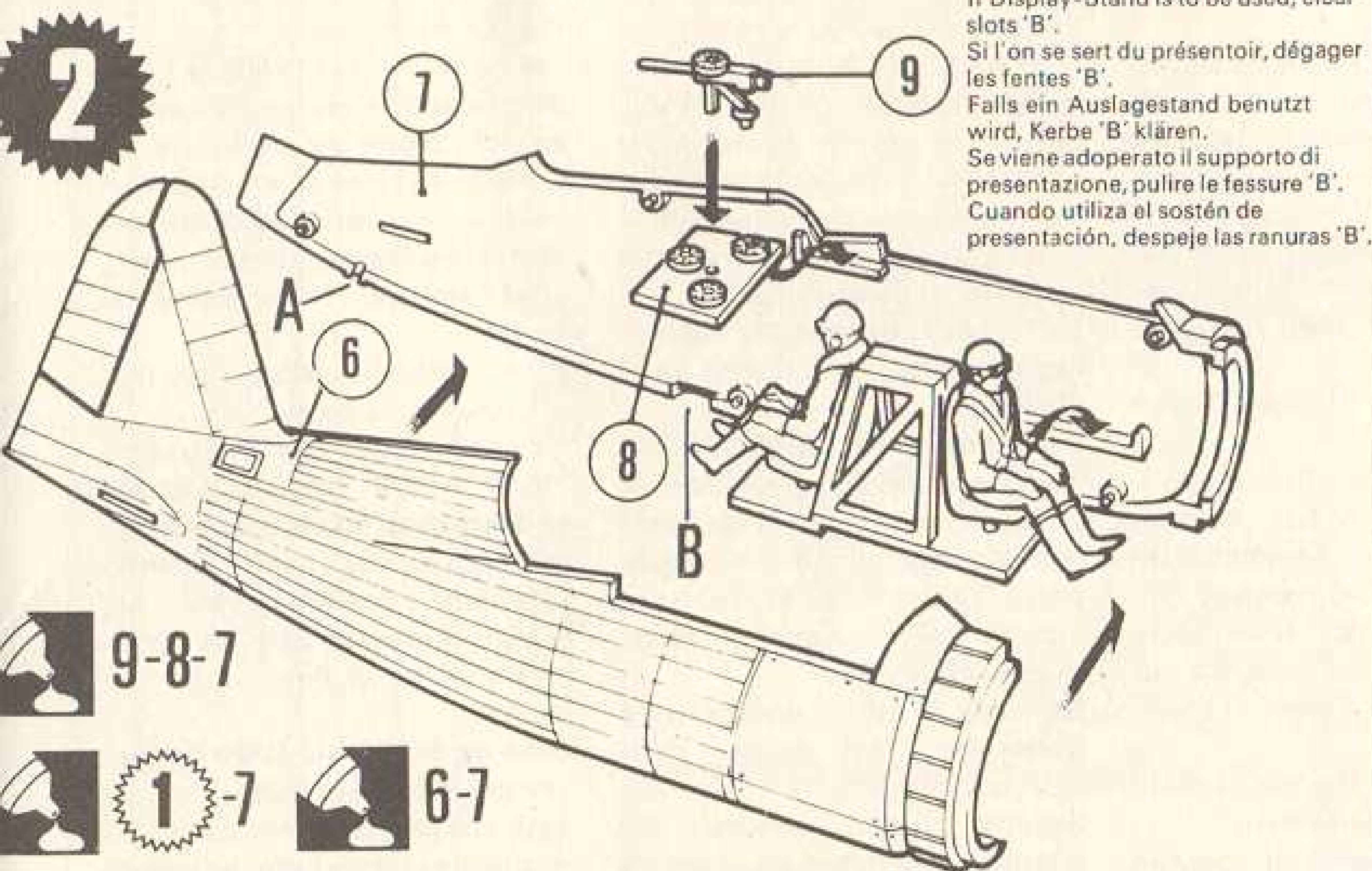

If Display-Stand is to be used, clear slots 'B'.  
 Si l'on se sert du présentoir, dégager les fentes 'B'.  
 Falls ein Auslagestand benutzt wird, Kerbe 'B' klären.  
 Se viene adoperato il supporto di presentazione, pulire le fessure 'B'.  
 Cuando utiliza el sostén de presentación, despeje las ranuras 'B'.

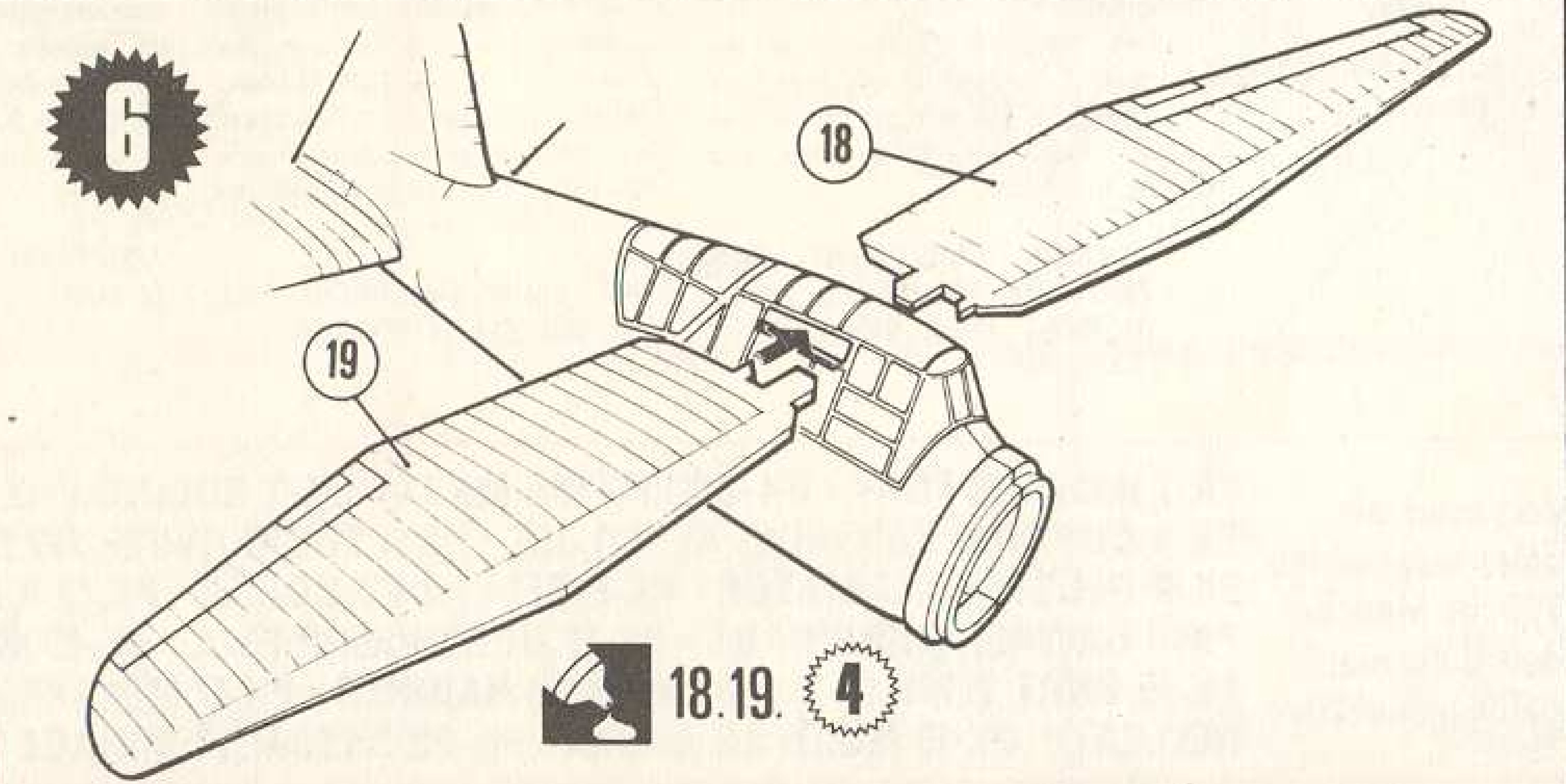
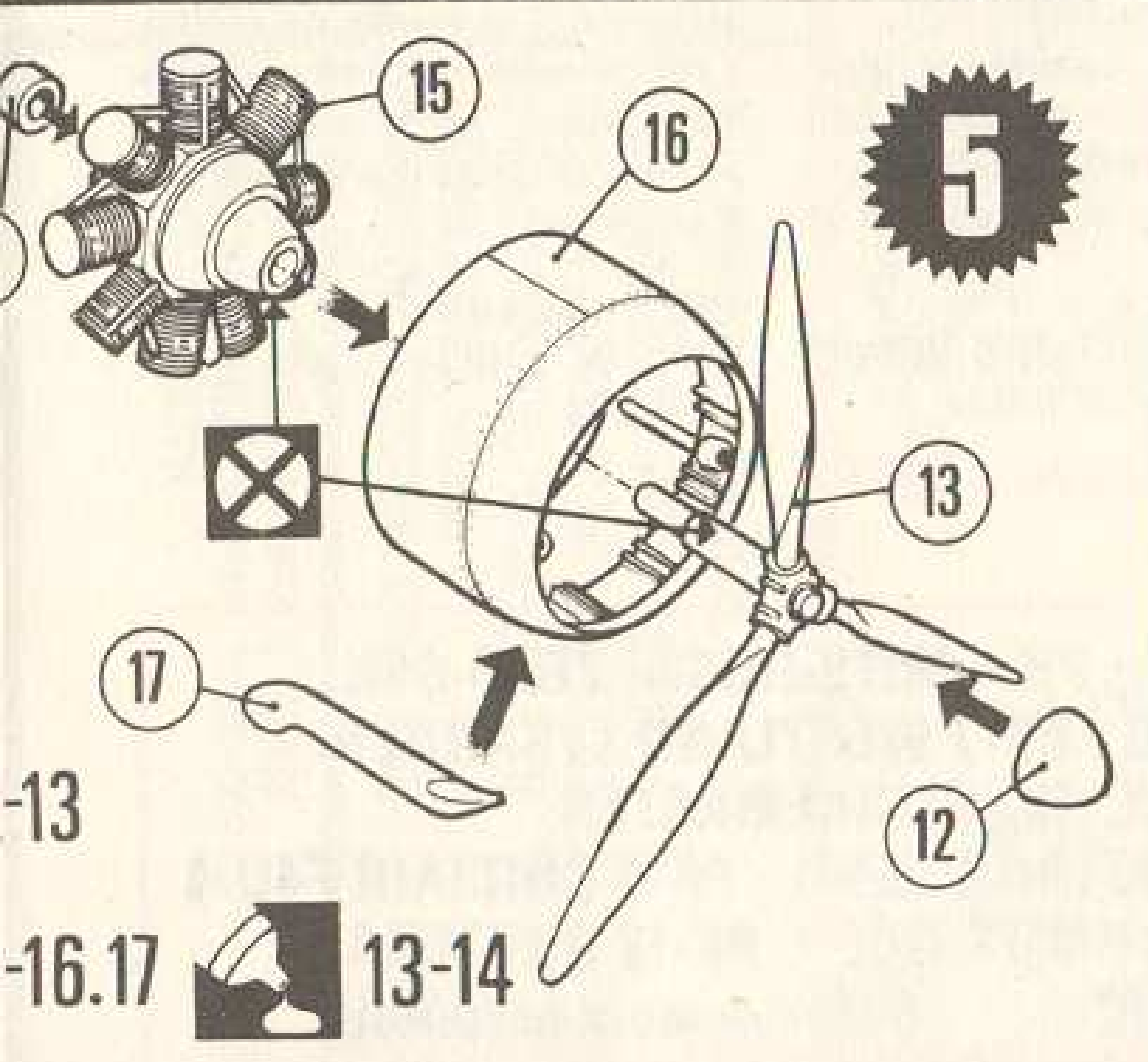
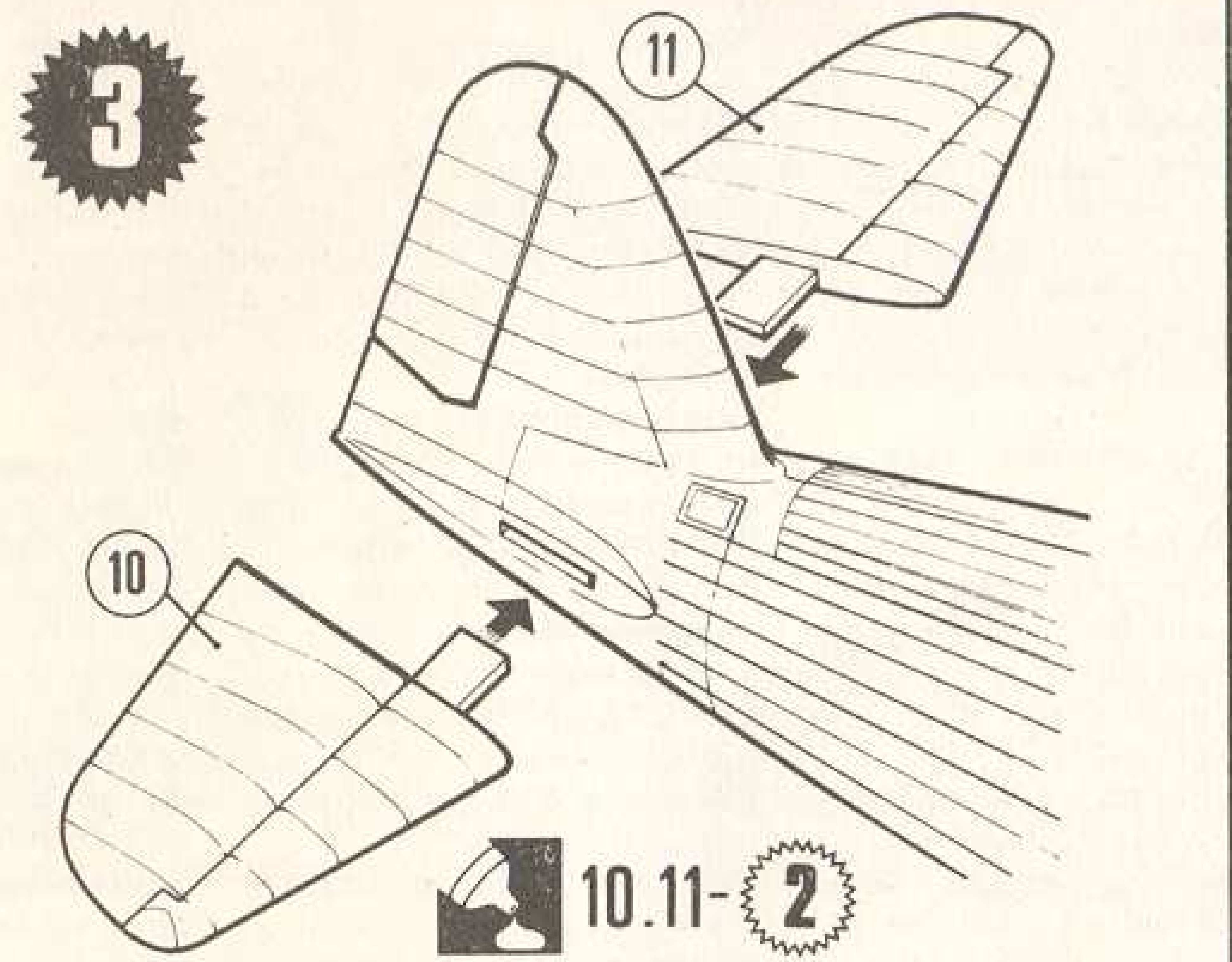

7

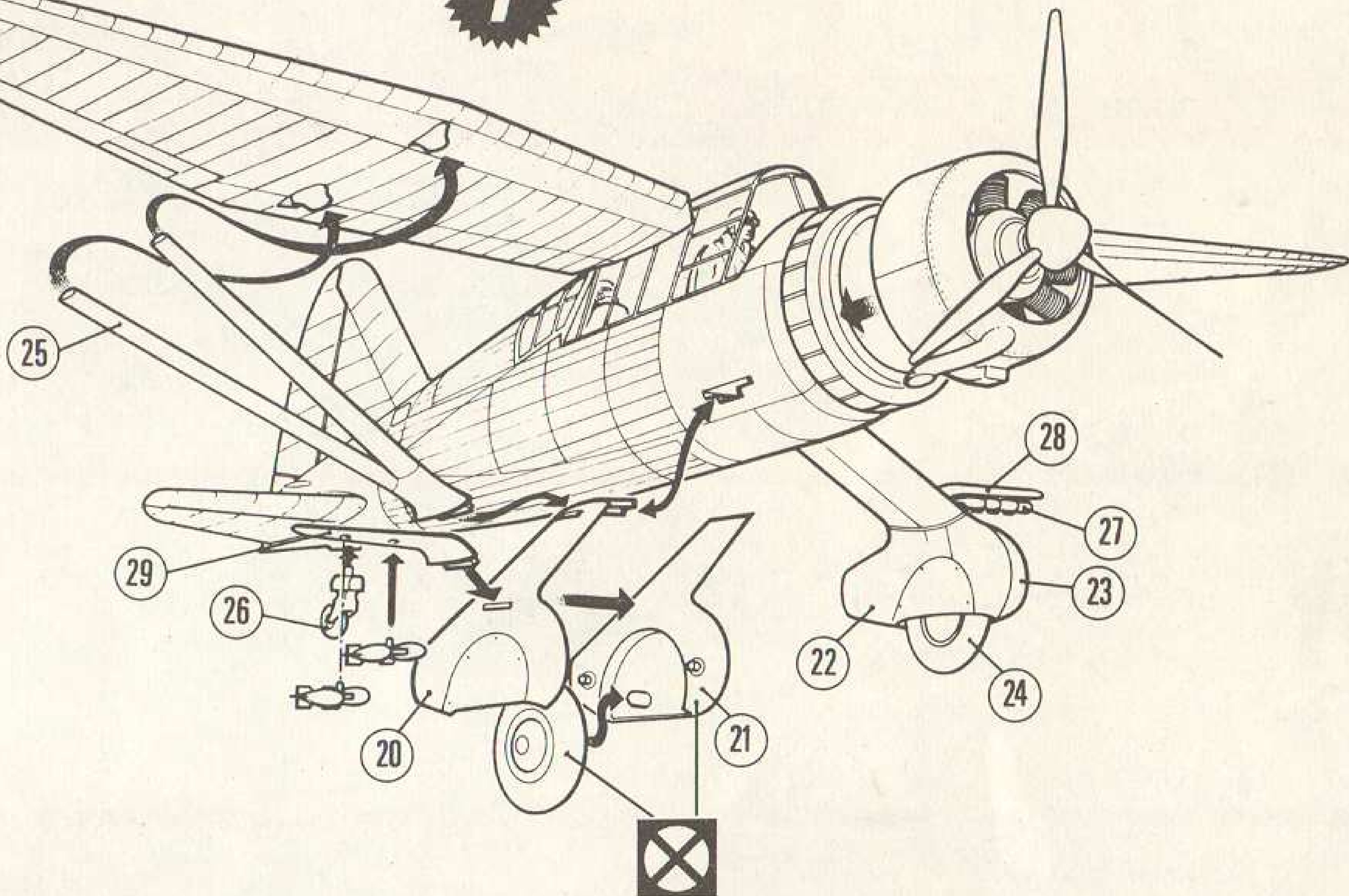

 20 - (~~24~~) - 21. 
  22 - (~~24~~) - 23. 
  25.26. 
  27-28.

 27-29. 
 



TECHNICAL INFORMATION AND ASSISTANCE BY RAF MUSEUM

EVERY CARE IS TAKEN TO ENSURE YOUR "MATCHBOX" KIT HAS BEEN MADE TO THE HIGHEST STANDARD. IN THE UNLIKELY EVENT OF A COMPLAINT PLEASE FILL IN THE ATTACHED FORM. (UK ONLY).

TOUS LES SOINS NECESSAIRES ONT ETE PRIS POUR ASSURER QUE VOTRE KIT "MATCHBOX" REPONDE AUX PLUS HAUTES NORMES DE QUALITE. EN CAS IMPROBABLE DE RECLAMATION, ON EST PRIE DE REMPLIR LA FORMULE JOINTE ET DE LA RENVoyer A VOTRE STOCKISTE LOCAL.

DIE GRÖSSTE SORGFALT WIRD ANGEWANDT, UM EINE MAXIMALE FERTIGUNGSGÜTE BEI IHREM "MATCHBOX"-MODELLSATZ ZU GEWÄHRLEISTEN. IM HÖCHST UNWAHRSCHEINLICHEN FALL EINER MANGELRÜGE, FÜLLEN SIE BITTE DAS BEIGEFÜGTE FORMULAR AUS UND SENDEN SIE ES AN IHRE VERKAUFSSTELLE ZURÜCK.

SI È USATA LA MASSIMA CURA PER ASSICURARE CHE IL VOSTRO KIT "MATCHBOX" RISPONDA ALLE PIÙ SEVERE NORME DI QUALITÀ. NELL'EVENTUALITÀ IMPROBABILE CHE SI PRESENTI LA NECESSITÀ DI FARE UN RECLAME, COMPILARE IL MODULO ALLEGATO E SPEDIRLO AL VOSTRO RIVENDITORE LOCALE.

HEMOS PUESTO EL MAYOR CUIDADO EN ASEGURAR QUE SU EQUIPO "MATCHBOX" CUMPLA LAS MAS ESTRUCTAS NORMAS DE CALIDAD. EN EL CASO IMPROBABLE DE QUE TENGA QUE HACER UNA RECLAMACION LE ROGAMOS RELLENE EL FORMULARIO ADJUNTO Y LO DEVUELVA A SU PROVEEDOR LOCAL.

© 1972 LESNEY PRODUCTS & CO. LTD

PRINTED AND MADE IN ENGLAND.