

AeroMaster.

48-128C



Mediterranean Bf 109s of JG 27



48-128C

3615 NW 20th Ave • Miami, Florida 33142 • USA
Tel. (305) 635-3134 • Fax (305) 638-4197

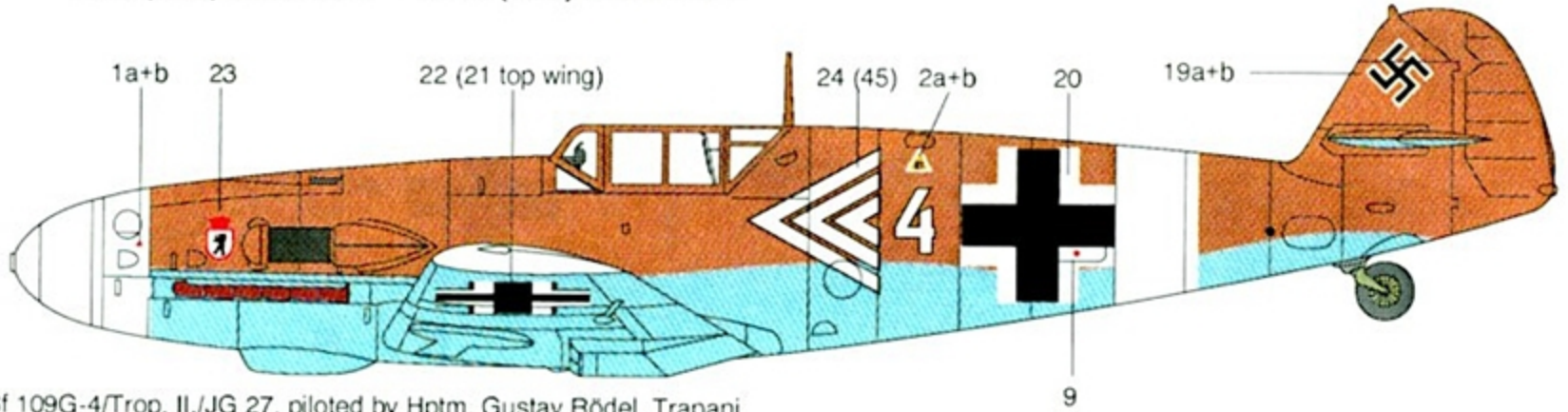

Bf 109G-4/Trop, II./JG 27, piloted by Hptm. Gustav Rödel, Trapani, Sicily, April, 1943. RLM 79 Sandgelb over RLM 78 Hellblau. Aircraft also sports a white fuselage band, wing tips & prop spinner.

Bf 109E-4, III./JG 27, flown by Hptm. Max Dobislav, Castel Benito, Sicily, May, 1941. RLM 74 Graugrün & RLM 75 Grauviolett over RLM 76 Lichtblau – with RLM 04 Yellow nose, white fuselage band, rudder and prop spinner tip. Mottling appears to be RLM 74.

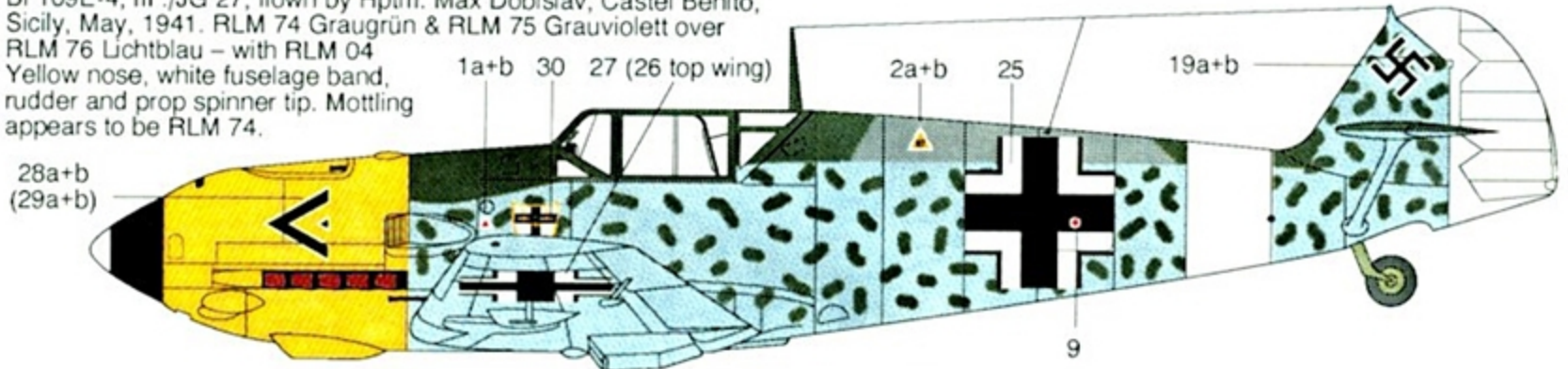

Bf 109G-6/Trop, 7./JG 27, piloted by Obl. Emil Klade, Kalamaki, Greece, Jan., 1944. RLM 74 Graugrün & RLM 75 Grauviolett over RLM 76 Lichtblau – with white fuselage band and rudder. Prop spinner is 1/3 white, 2/3 black. Mottling is RLM 74/75

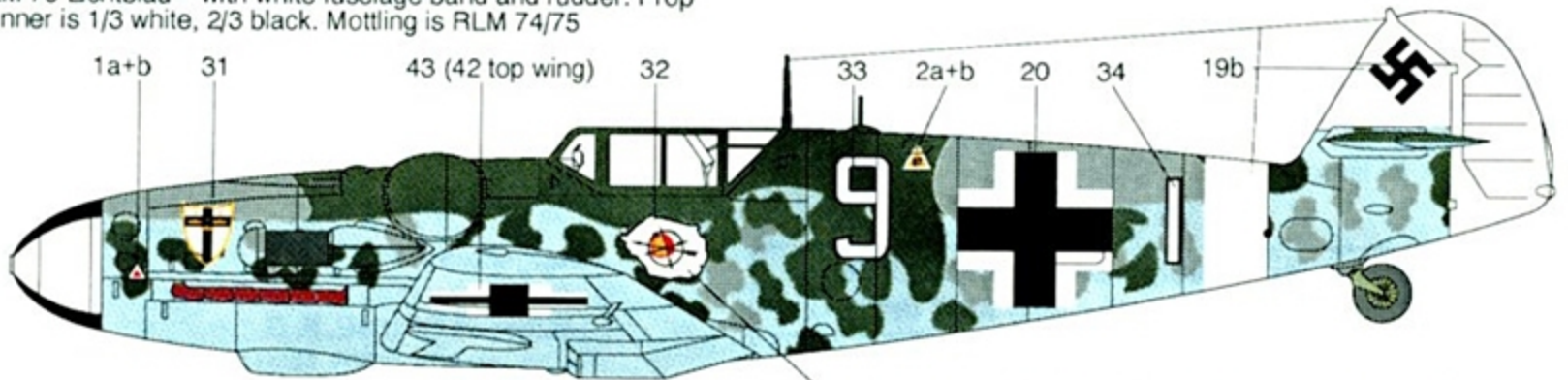

(note: an additional 32 is supplied for the starboard side, although some experts doubt that Klade's aircraft carried this marking there.)

Bf 109G-6/R6, 11./JG 27, piloted by Fwbl. Heinrich Bartels, Kalamaki, Greece, ca. Sept., 1943. RLM 74 Graugrün & RLM 75 Grauviolett over RLM 76 Lichtblau – with white fuselage band and rudder. Prop spinner is white with black spirals. RLM 74/75 fuselage mottling.

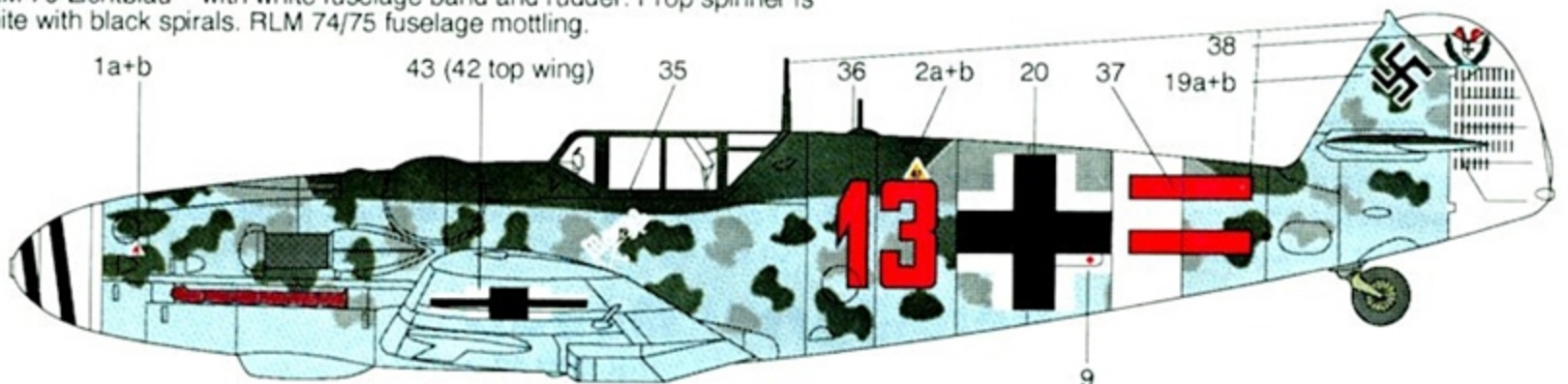

AeroMaster Decals™

Bf 109G-2/Trop, 8./JG 27, piloted by Hptm. Werner Schroer, Rhodes, ca. Feb., 1943. RLM 74 Graugrün & RLM 75 Grauviolett over RLM 76 Lichtblau – with white prop spinner and fuselage band. Rudder is red. RLM 74/75 fuselage mottling.

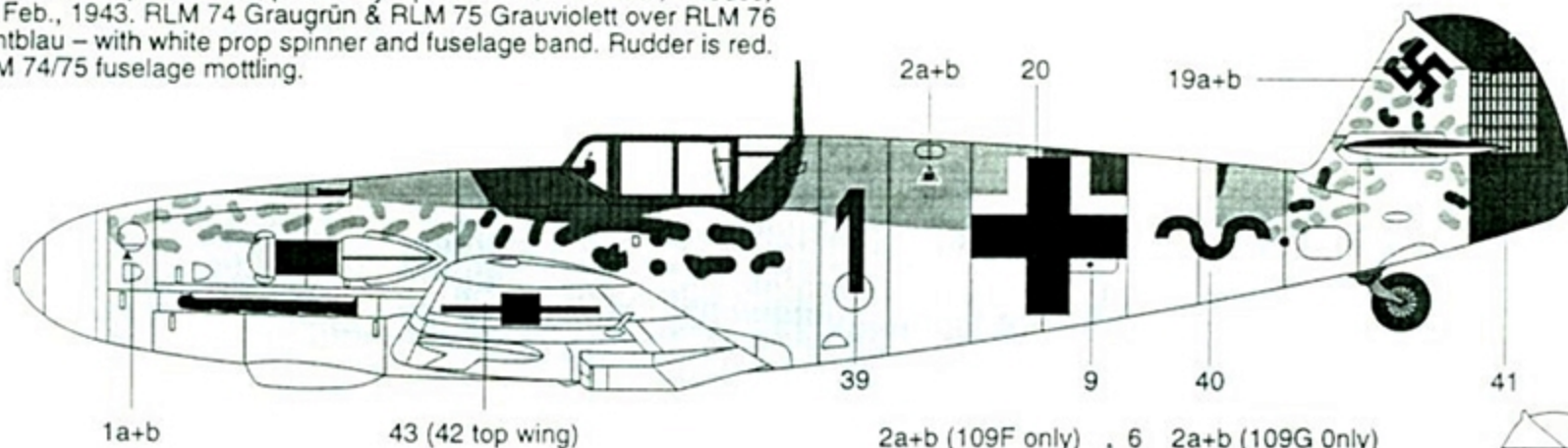

GENERAL 109F/G STENCIL & MARKINGS PLACEMENT

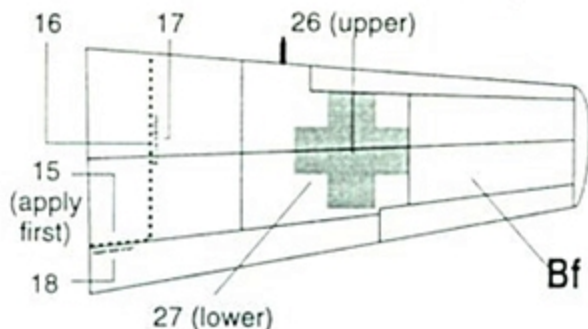
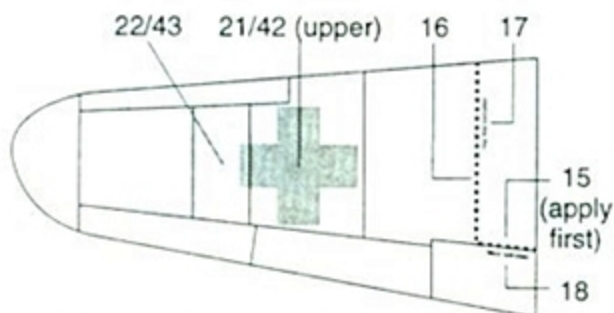
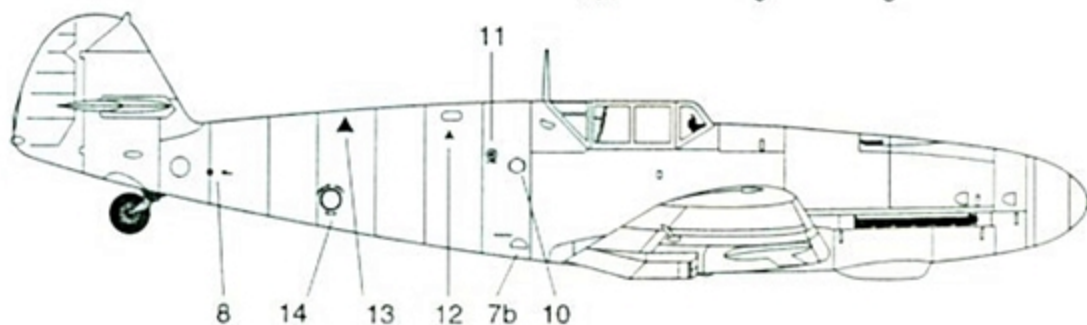
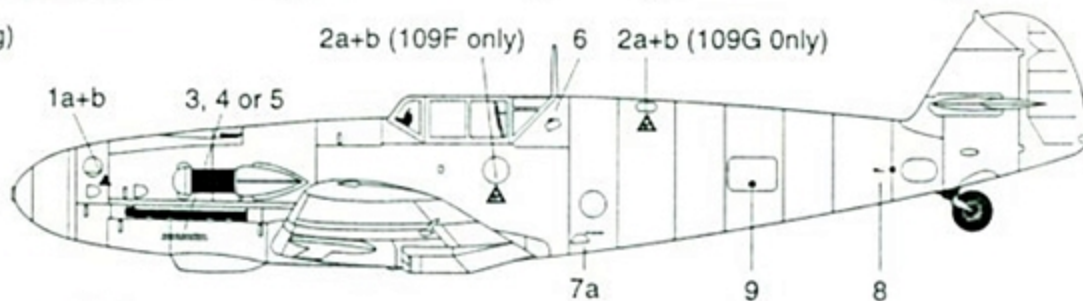

Bf 109E wing markings

(Consult references & photos for upper-surface camouflage patterns — and stencil placement for Bf 109E variants)

We recommend **AeroMaster Warbird Colors** to compliment your high quality **AMD** decals

Colors required to complete the aircraft depicted on this decal sheet.

9001 Black	9025 RLM 74 Graugrün
9002 White	9026 RLM 75 Grauviolett
9003 Yellow	9027 RLM 76 Lichtblau
9004 Blue	9033 RLM 78 Hellblau
9005 Red	9034 RLM 79 Sandgelb
9010 Tire Black	9035 RLM 80 Olivgrün
9020 RLM 02 Gray	9036 RLM 04 Gelb

Suggested Kits:

Hasegawa Bf 109E, F, G
Hobbycraft Bf 109E, G

References:

1. *Bf 109 Aces of North Africa and the Mediterranean* by Jerry Scutts (Osprey Aircraft of the Aces 2, Osprey Aerospace, 1994).

If you have suggestions for future subject matter, AeroMaster would like to hear from you. Our goal is to provide high quality, well researched decals of unusual and interesting subjects. We value our customers' inputs, so if you have specific suggestions or photographs of unusual subject matter which you would be willing to share, please contact:

AeroMaster Decals™

3615 NW 20th Ave • Miami, Florida 33142 • USA